



European Union  The European Regional Development Fund

## The Interreg IVB North Sea Region Programme

*Investing in the future by working together  
for a sustainable and competitive region*



# ACCSEAS Final Annual Conference Report

Issue: 1

Issue Status: Approved

Issue Date: 27/04/2015

Lead Author	Reviewer	Approved for Release
<b>Name:</b> Alwyn I. Williams	<b>Name:</b> Transnational Project Co-ordination Group	<b>Name:</b> Project Steering Committee
<b>Job Title:</b> ACCSEAS Project Manager	<b>Job Title:</b> Transnational Project Co-ordination Group	<b>Job Title:</b> Project Steering Committee
<b>Partner:</b> Project Bureau	<b>Partner:</b> All	<b>Partner:</b>
<b>Signature:</b> pp. Alwyn I. Williams	<b>Signature:</b> pp. Alwyn I. Williams	<b>Signature:</b> pp Alwyn I. Williams

## *Disclaimer*

Please note the views expressed and reported within this document are not necessarily those of the project or the project partners.

## Contents

1	Introduction .....	7
2	Day 1.....	7
2.1	Welcome and introduction. Mike Bullock and Kees Polderman.....	7
2.2	Opening speech, Brigit Gijsbers.....	7
2.3	Setting the scene .....	8
2.3.1	The ACCSEAS Project .....	8
2.3.2	North Sea Region challenges .....	10
2.3.3	e-Navigation framework status.....	11
2.4	ACCSEAS e-Navigation test-bed solutions .....	14
2.4.1	The need for Resilient Position, Navigation and Timing .....	14
2.4.2	The test results for Resilient PNT in the NSR.....	14
2.4.3	Maritime Cloud / Maritime Communications.....	17
2.4.4	Introduction – Route Topology Model for the NSR .....	18
2.4.5	Mariner’s perspective on the NSR-RTM.....	19
2.4.6	How NSR-RTM may support vessel traffic flow throughout the region .....	23
2.4.7	NSR-RTM as an ACCSEAS legacy for Europe .....	24
3	Day 2.....	25
3.1	Review of workshop results .....	25
3.1.1	3rd North Sea Region e-Navigation User Forum: Maritime Cloud .....	25
3.1.2	3rd North Sea Region e-Navigation User Forum: Resilient PNT .....	26
3.1.3	3rd North Sea Region e-Navigation User Forum: Route Topology Model .....	26
3.2	ACCSEAS e-Navigation test-bed solutions (cont.) .....	28
3.2.1	Maritime Safety Information and Notices to Mariners (T&P) service.....	28
3.2.2	Tactical Route Exchange (Route suggestion / Route exchange).....	29
3.2.3	Augmented Reality .....	31
3.2.4	Q&A Session .....	33
3.2.5	No-go area Service .....	34
3.2.6	Inter VTS Exchange.....	36
3.2.7	Vessel Operations Co-ordination Tool .....	38
3.2.8	Dynamic Predictor for tugboat operation .....	39
3.2.9	Automated FAL Reporting.....	41
3.2.10	Q&A Session .....	42
4	Day 3.....	43
4.1	Workshop Results.....	43
4.1.1	3rd North Sea Region End User Forum: A Sparks from ACCSEAS .....	43

4.1.2	3rd North Sea Region End User Forum: B The Monitoring Navigator .....	45
4.1.3	3rd North Sea Region End User Forum: C North Sea Region future challenges 47	
4.1.4	3rd North Sea Region End User Forum: D Chances and challenges of simulation networks.....	50
4.2	ACCSEAS' Project achievements .....	53
4.3	Legacy and Future Work, Outline Sustainable Work Plan .....	53
4.4	Keynotes: Future Perspectives .....	55
4.4.1	Safety and accessibility, Francis Zachariae .....	55
4.4.2	Shipping perspective, Fredrik Van Wijnen.....	56
4.4.3	Green perspective, Sjon Huisman.....	56
4.4.4	Port perspective, Rob Gutteling .....	58
4.5	Debate - Future Shipping in the North Sea Region .....	59
4.6	Close - Conference Chair, Mr. Kees Polderman .....	60

**Document Disclaimer**

Document is uncontrolled when removed from iManage (either electronic or printed)
---

**Document Information**

Project Title	ACCSEAS
Work Package No.	2
Document Title	ACCSEAS Final Annual Conference Report
Description	Summary of the presentations and discussions during the ACCSEAS Conference in 2015.
Date	27/04/2015
Lead Author	Alwyn I. Williams
Lead Author's Contact Information	Dr Alwyn I. Williams ACCSEAS Project Bureau GLA R&RNAV, Trinity House, The Quay, Harwich, Essex CO12 3JW Direct: +44 (0) 1255 245134 Mobile: +44 (0) 7739 191253 E-mail: alwyn.williams@gla-rnav.org
Contributing Author(s)	Phillip Cruddace, Transnational Project Co-ordination Group
iManage Location	29829
Circulation	1. Client 2. Project Files (i-manage) 3. Transnational Project Co-ordination Group 4. Project Steering Committee
NSRP Secretariat Approval	Yes / No



## 1 Introduction

The Final ACCSEAS Conference was held at Beurs WTC, Rotterdam, The Netherlands on 17<sup>th</sup> – 19<sup>th</sup> February 2015. This report summarises the discussions and conclusions of the Conference.

Presentations and videos of the presentations are available on the ACCSEAS website ([www.accseas.eu](http://www.accseas.eu)), and should be consulted with reference to the summaries given below.

## 2 Day 1

### 2.1 Welcome and introduction. Mike Bullock and Kees Polderman

Mike Bullock, as Chief Executive, Northern Lighthouse Board, and Chair, ACCSEAS Project Steering Committee proudly welcomed delegates to Rotterdam and the final ACCSEAS Conference. He introduced the Kees Polderman and his history as a maritime professional before inviting him to take his position as chair of the conference.

Kees Polderman thanked all of the delegates and welcomed them to the conference. He made special mention to those who have come from outside Europe.

Mr Polderman discussed the history of e-Navigation, from its inception until the adoption of the Strategy Implementation Plan by IMO in 2014, noting the work still left to be done. “Ultimately e-Navigation can only be made to work as an international system – but there is also much more being done at national and regional level”.

He noted that now, 10 years on from e-Navigation’s conception, we can see the achievements at a regional level in this project, and learn how ACCSEAS can contribute to global e-Navigation.

He then invited Brigit Gijsbers to deliver her speech, officially opening the Final Conference.

### 2.2 Opening speech, Brigit Gijsbers

Brigit Gijsbers, Netherlands Director Maritime Affairs, thanked the organisers for the opportunity to speak at the Final Conference. She commended the choice of location, noting that Rotterdam is the largest seaport in Europe and gateway to the continent.

Rotterdam is a traditional historic maritime nation, whose zenith was in the 17<sup>th</sup> and 18<sup>th</sup> century with the Dutch East India Company and West India Company. They brought back raw materials and previously unknown goods for use in the Netherlands and trade abroad. Because of this, the Dutch had the nickname ‘Traders of the Sea’ and became very wealthy.

The accessibility of the Dutch ports is of vital importance to the continuation of the excellent reputation of the Netherlands as a maritime nation, as well as for the growth of its GDP and its connections to the hinterland. Whilst the Netherlands has more than 243,000 ship movements on its coast, the nation realises that shipping is no longer the main user of the sea. It shares space with wind farms, oil platforms, fishing vessels and conservation areas resulting in reduced navigational space.

The ACCSEAS Baseline and Priorities Report shows the clear and worrying picture of shipping in the North Sea Region. This report can be considered a wake-up call for all responsible nations bordering the North Sea. The demands are changing and so are the needs of its stakeholders.

The IMO concept of a Sustainable Maritime Transport System is the framework to support integrated logistics from a maritime perspective with enhanced ship and shore connection. A

comparable initiative at EU-level is its e-Maritime concept. e-Navigation, with its harmonised concept of harmonised solutions at its core, can contribute to these initiatives.

e-Navigation solutions on their own will not be enough to solve the problem identified in the ACCSEAS Baseline and Priorities Report. Maritime Spatial Planning and other traffic services may contribute. Given the transnational nature of the North Sea Region, it is important that there is cooperation between the regions and nations.

There was confidence that a combination of the outcome of projects such as ACCSEAS, coupled with its legacy, can contribute to e-Navigation and the future transnational coordination in the North Sea Region. Netherlands will be ready to contribute in a common approach to this.

## 2.3 Setting the scene

### 2.3.1 The ACCSEAS Project

Dr Williams began his presentation by noting that he will provide a brief overview of the project as a whole, with the details coming later from project partners. He intended to provide an introduction to ACCSEAS for those people in attendance that are new to the project.

The aim of ACCSEAS is to improve maritime accessibility in the North Sea Region by using the IMO concept of e-Navigation. ACCSEAS consists of 11 partners from 6 countries bordering the North Sea.

The project began by identifying what the challenges in the North Sea Region are: increased shipping density, with more traffic and bigger vessels and; the growth in offshore installations causing reduced sea-space and manoeuvrability. This poses a real challenge to the accessibility of our region via our ports.

ACCSEAS employed a systems engineering approach with three stages: looking at the requirements, designing and implementing solutions, then verifying and validating the results.

The project began by analysing the region, both as it is now and as it will be in the future. The Baseline and Priorities Report looked at traffic density in the region, added wind farms and other offshore installations to show a picture of the region today.

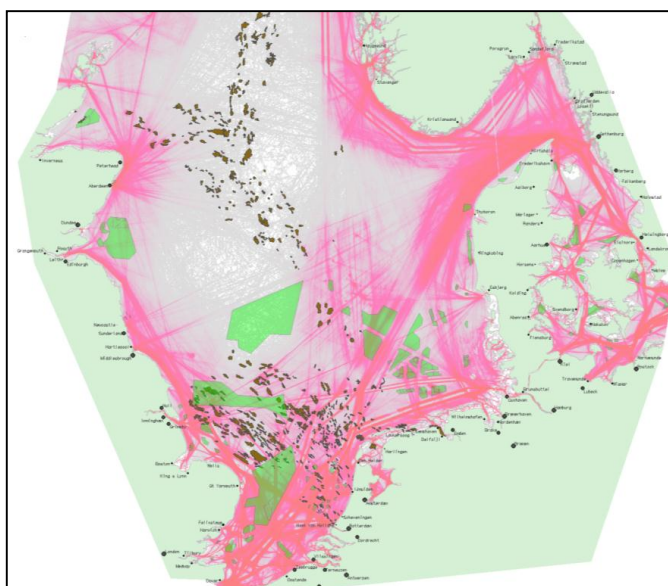



This image shows the areas where conflicts can occur, and with more windfarms planned and traffic density increasing this picture will only become more congested.



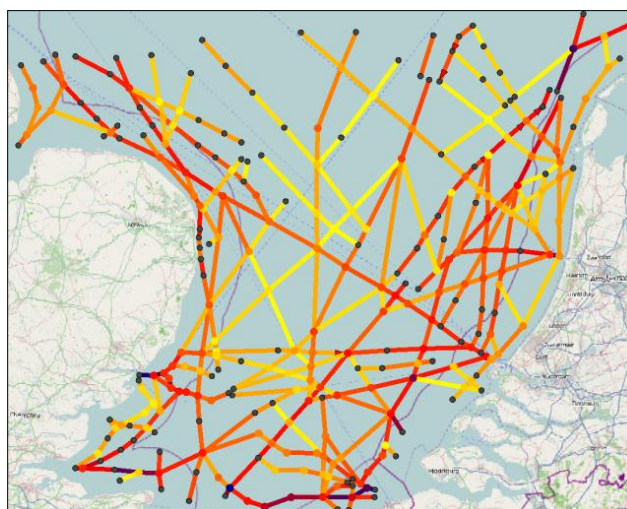







The report also created a risk analysis map of the major routes in the region, identifying key areas of the North Sea where risk of collision or grounding is increased.



The First Annual Conference covered the challenges to the region and gave delegates an opportunity to hear about the proposed e-Navigation solutions. It was also host to the inaugural e-Navigation Users Forum.

The next step for the project was to design the test-bed based on the IMO e-Navigation concept and with guidance from IALA & IHO. The project further developed the Maritime Cloud as a secure means of communicating between different actors, providing the essential communications framework for all of the other services developed within the test-bed. The individual services were developed within the test-bed, with the e-Navigation Architecture Report providing further information on the test-bed and its solutions.

The list of potential solutions developed by the project:

-  Resilient Positioning, Navigation and Timing (PNT)
-  Tactical Route Exchange and Route Suggestion
-  Route Topology Model
-  Maritime Safety Information/Notice to Mariners
-  No-go Area Service
-  Augmented Reality Heads-up Display
-  Automated FAL Reporting
-  Vessel Operations Co-ordination Tool
-  Dynamic Ship Movement Prediction
-  Inter-VTS Exchange System

The goal of the solutions is to enhance accessibility by improving maritime safety and

efficiency, and to improve spatial awareness and communication integrity between ship and shore.

The Second Annual Conference was in Edinburgh, March 2014, where basic prototypes of the solutions were shown in more detail. This was an opportunity to gain feedback from stakeholders via the second e-Navigation forum. This feedback was used by them partners when implementing the solutions.

Once the project partners had developed the solutions, they used real and simulated environments to test their functionality. This involved both sea-going and shore-based professionals, creating a forum for feedback.

Throughout the project, the impact of the new technology on training was analysed and understood. Each demonstration and trial goes towards understanding the future needs of training mariners in this brave new world. ACCSEAS published the Use of Simulators in e-Navigation Training and Demonstrations Report and will publish the Training Needs Analysis Report which explores this crucial aspect more thoroughly and will go a long way to understanding the requirements from an educational point of view.

Dr Williams finished by welcoming everyone to the final conference, where delegates will see the solutions in detail and get a chance to feed back their impressions of the project.

### 2.3.2 North Sea Region challenges

Professor Porathe discussed four key challenges he noticed coming from the project.

The first challenge facing the region is the decrease of sea space. Two years ago, at the First Annual Conference the below picture was shown:

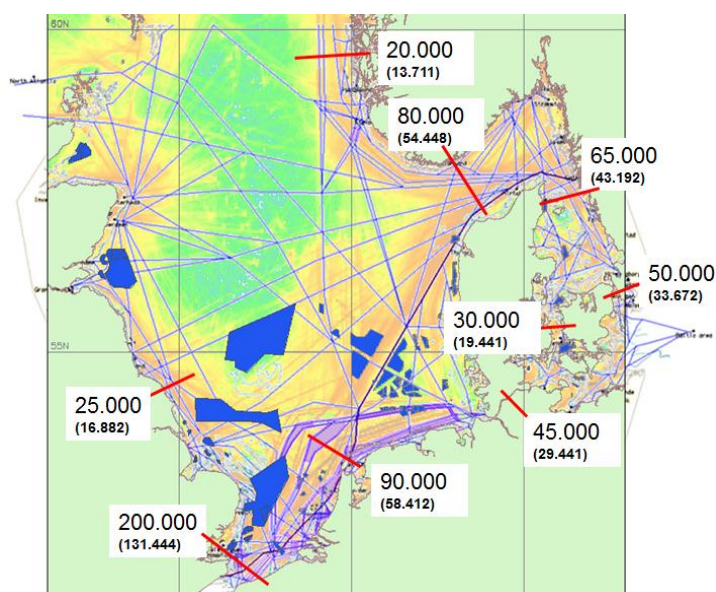

This picture, showing the growth in shipping density alongside the wind farm installations to 2020 and beyond, was a surprise to many people, but it illustrates the challenge facing the region in terms of sea space.

Looking at [www.4coffshore.com](http://www.4coffshore.com), a picture of the offshore installations can be seen and the shipping lanes within them. Currently wind farms are being installed in shallow water (20-30m), but with new technology it opens up the possibility of 100m depth. This will result in more wind-farms taking up more space in the region.

Wind farms are not the only user of the marine space in the North Sea – we are seeing the advent of wave energy and ocean farming, an incredibly efficient and way of raising fish.

Ocean farms are often in depths of 100m-300m. While we appreciate that this is an initiative that will help mitigate our demands on natural resources, it is something that shipping needs to deal with.

The second challenge is the increase in ship traffic. In the ACCSEAS Project, the Danish Maritime Authority used AIS data to project how many ships travel in each area of the North Sea Region every year. It found that the Dover Strait, with 131,000 passages, is the busiest area. The Danish Maritime Authority projected that in 2020 this traffic will increase by 1.5. In the two years since this study it appears that 1.5 may have even been a conservative estimate.

The third challenge is the increase in the complexity of navigation. This is a result of a combination of the reduced sea space for navigation and the increasing number of ships (Challenges 1 & 2), as well as the gradual increase in vessel size.



Here is a picture of a shipping lane in the North Sea from [www.4coffshore.com](http://www.4coffshore.com) again. With the traffic separation scheme and the offshore installations, you can see a clear point where two well-frequented shipping lanes intersect. This can be managed without issue if all of the conditions are perfect. But this can become challenging in bad weather and with tired navigators.

The fourth challenge is the new challenge for the navigator that is engendered by e-Navigation. The potential of a 'Monitoring Navigator'. The excellent navigation tools produced already: radar, autopilot, GPS, AIS, ECDIS, have the potential to produce a Navigating Automaton (a computer that does the navigating) and a Monitoring Navigator (a human who monitors the computer) How do we make sure we keep the navigator in the loop? This is the biggest challenge of all.

The goal at the heart of ACCSEAS and e-Navigation is the desire to split that relationship and make sure that any technologies we create to mitigate for the first three challenges result in the retention of a Navigating Navigator and produce a Monitoring Automaton. This ideal can be compared to the perfect English butler – always behind is master, serving him when he needs it and will stopping him from looking like an idiot.

### 2.3.3 e-Navigation framework status

Pieter Paap used his presentation to describe the concept of e-Navigation; give an overview of the process that has gone on so far; explain where we are now; and highlight the framework.

Ten years ago we identified some key issues facing shipping: an increase in maritime transport, an increase in shipping density, the move towards larger, faster ships and the increasing demands for alternative utilisation of the sea. The industry globalised and

increased the demand for optimising the connection between shipping and the logistics chain, culminating in the need to enhance efficiency and the demand for new technology to enable this.

It was foreseen that new services, decision-making tools, hardware and software would be required. The increase in piracy also meant that security fears increased the requirements for reliable and secure data exchange. But because of the strength of this demand legislation is often left catching up with technological developments. The demand for coherence is growing.

Slowly and surely, the expertise needed to achieve this has faded and the pools of candidates ashore dried up. There emerged gaps in training between theory and practice. New training methodologies were needed.

In 2004, IMO assessed the risks to safety, efficiency, accessibility and the environment around the issues facing shipping. Two aspects were isolated: the need for harmonisation and standardisation. Concerns were raised that a lack of harmonisation would lead to a proliferation of services and non-approved applications. Legislation needed to be introduced to mitigate for this, while considering that it could have a negative effect on interoperability. Out of the need for harmonisation and standardisation came the need to develop a strategy for e-Navigation.

The conditions for e-Navigation, within the IMO strategy were that it would be: user driven, holistic and integral, harmonised and standardised, enhancing ship-shore & ship-ship interaction, employing modern technology, scalable, conscious of the human factor and ongoing.

e-Navigation would aim to promote standardisation, uniformity and interoperability, as well as making sure that it would be integrated within systems. It must support save navigation and vessel monitoring, contributing to efficiency and effective search and rescue and disaster response. Training requirements and system familiarisation is essential to the effective implementation of e-Navigation.

From this the IMO devised its definition of e-Navigation: The harmonized collection, integration, exchange, presentation and analysis of marine information onboard and ashore by electronic means to enhance berth to berth navigation and related services for safety and security at sea and protection of the marine environment.

What are the core elements of e-Navigation? The three basic elements are reliable and accurate navigation systems, old and new communications systems to manage data flows and ENC's in combination with ECDIS to represent the data onside and ashore. Uniform formats that meet user needs are important in the core of e-Navigation. Training and economic aspects must also be considered.

It is important to harmonise and standardise the new e-navigational services will be brought together in a functional and technical stream with interoperability. This is the Maritime Service Portfolio – which needs a well-defined architecture with unambiguous definitions and descriptions, a shared data model all brought together in one S-100 register from the IHO. This will be the one main harmonised source with open interfacing used where appropriate. IALA is required to develop a methodology to support the architectural design of Maritime Service Portfolio, taking on board the 7 pillars approach.

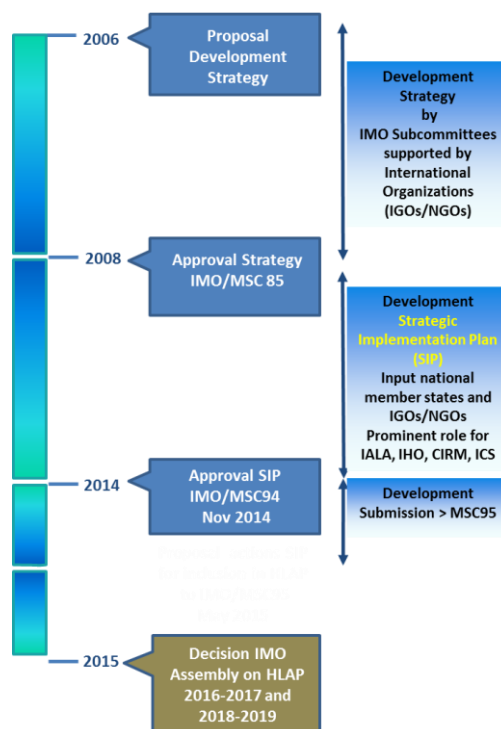

Some member states are currently preparing a proposal to IMO on the actions from the Strategy Implementation Plan, with approval expected in December 2015. In the meantime, standards and solutions are being developed.

The tasks in the SIP which are completed are:

- Identification of the Users
- Identification User requirements
- IMO Formal Safety Assessment (FSA)
- Regulatory framework/technical requirements for solutions
- Identified 6 areas for the delivery of Maritime Service Portfolios (MSPs)
- A preliminary list of 17 Maritime Service Portfolios
- Identification of 18 tasks proposed to be executed in the period 2015-2019

Guidelines complete:

- Guideline on Human Centred Design (HCD) for e-navigation
- Guideline on Usability Testing, Evaluation and Assessment (U-TEA) (systems)
- Guideline for Software Quality Assurance (SQA) in e-navigation
- Guidelines on Harmonization of test beds reporting (MSC.1/Circ.1494).

e-Navigation is developed under the umbrella of SOLAS (the International Convention for the Safety of Life at Sea) and its amendments – it provides the guidelines for vessels with respect to safety, specifically chapters 4 and 5 are relevant for e-Navigation. UNCLOS (the United Nations Convention on the Law of the Sea) is another element that makes up the framework – it designs the rights, responsibilities and constraints for the world's oceans. Added to this are inputs from international organisations including IALA, IEC, IHO and ITU. The EU also influences e-Navigation, as well as e-Navigation contributing to EU initiatives such as eMaritime.

## 2.4 ACCSEAS e-Navigation test-bed solutions

### 2.4.1 The need for Resilient Position, Navigation and Timing

Dr Alan Grant's presentation was to introduce what Resilient PNT is, why there is a need for it and what life would be like if we did not have it.

In the commercial maritime world, GPS is the normal means of achieving position. It appears all over a ship: on the ECDIS, AIS, the gyro, the RADAR and the ship's clock, amongst others; it even features in the engine room and cabins. A lot of systems on a ship rely upon accurate positioning information

So what happens if it is no longer there? GPS is not the only GNSS (Global Navigation Satellite System) available. There is the Russian GLONASS and the European Galileo amongst others. These systems all operate on similar frequencies, and if there is any interference then it can take them all out in one go.

Interference can come from natural events, such as space weather and other ionospheric activity. It can also come from mechanical problems from failing equipment, but it can also be intentional through either jamming or spoofing. Jamming is where someone wilfully prevents signal reception by effectively shouting over the weak signal from the satellites and spoofing is where someone attempts to fool your receiver.

What contributes to a GPS failure? There are instances of natural and intentional damage. There was a GLONASS failure in April 2014 – it took the system off air for up to 10 hours and position errors of up to 200km occurred, this was due to a problem of someone uploading the wrong data. There were two solar flares in September 2014, this affects GPS signals and the vessel lost position on their AIS.

There is also intentional interference – a jammer in a van took down Newark airport while believing he was only going to affect his own vehicle. Dr Grant showed the ACCSEAS jamming trial video from 2013 as an indicator of what happens and how much of a navigator's time and focus is taken by a loss of GPS, concluding that we need something to mitigate these risks.

What do we need to do this? A system that will identify when GNSS is disrupted or unreliable and inform the mariner then mitigate the effect of losing GNSS and allow the mariner to continue operations. The ACCSEAS project has been considering how best to achieve this and Dr Grant handed over to Dr Paul Williams to elaborate.

### 2.4.2 The test results for Resilient PNT in the NSR

The ACCSEAS Project, in terms of Resilient PNT, has two important and novel results. First is the ACCSEAS receiver – the world's first prototype Multi-Source Resilient PNT Receiver based on GNSS as primary PNT source, integrity algorithms and a terrestrial (frequency and system diverse) backup. Second is our work on R-Mode – we have investigated a way of adding ranging signals to already existing IALA DGPS radio-beacons and AIS VHF base-station transmissions. Michael Hoppe of WSV will discuss further the Feasibility Study and Trial for this.

Below is a picture of the architectural structure of a shipboard Resilient PNT Receiver.

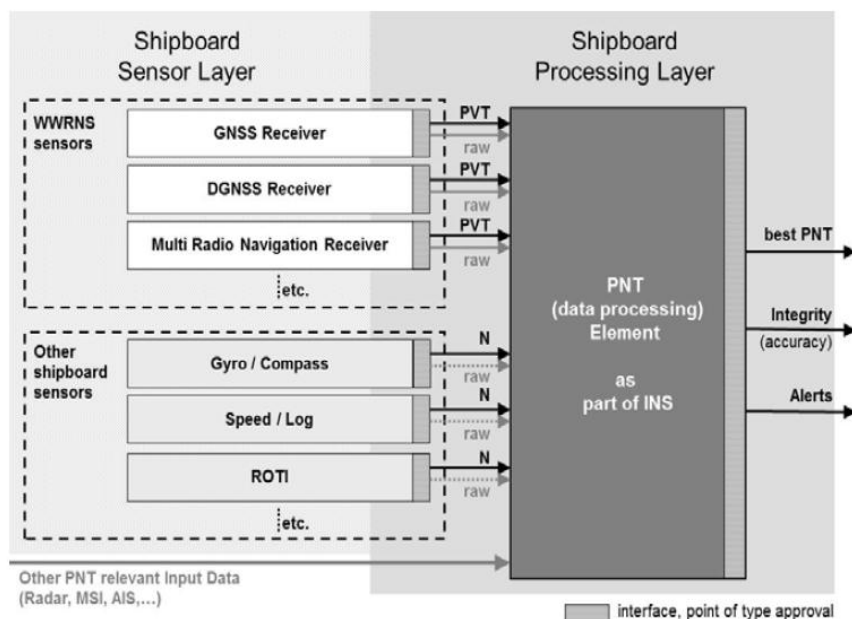

There are sensors for each data source which feeds the data it receives into the processor. The processor uses an algorithm to make a decision on what is the source of PNT with the most integrity; it then makes a decision of how to do to inform the mariner.

When deciding which data sources to use which would support and make GNSS more reliable we found you can harden the existing systems to make them more accurate and robust – for example adaptive antennas and plausibility checks of algorithms. We decided to do concentrate on dissimilar services to GPS – eLoran and R-Mode – we used these two to demonstrate its possibility.

The project looked at Radar Absolute Positioning, upgrading radar so not only does it give you relative position but also Latitude and Longitude using a modern technology called eRacons. If you have two eRacons working together you can get position of your ship up to 2m.

eLoran has been operating in the North Sea Region for a number of years and accuracies of 10-20m are possible today.

In the project, an architecture was developed and implemented for the receiver. We have a receiver with eLoran and capability for others that could be connected to the ECDIS or e-Navigation Prototype Display (EPD).

Below is what it looks like inside:

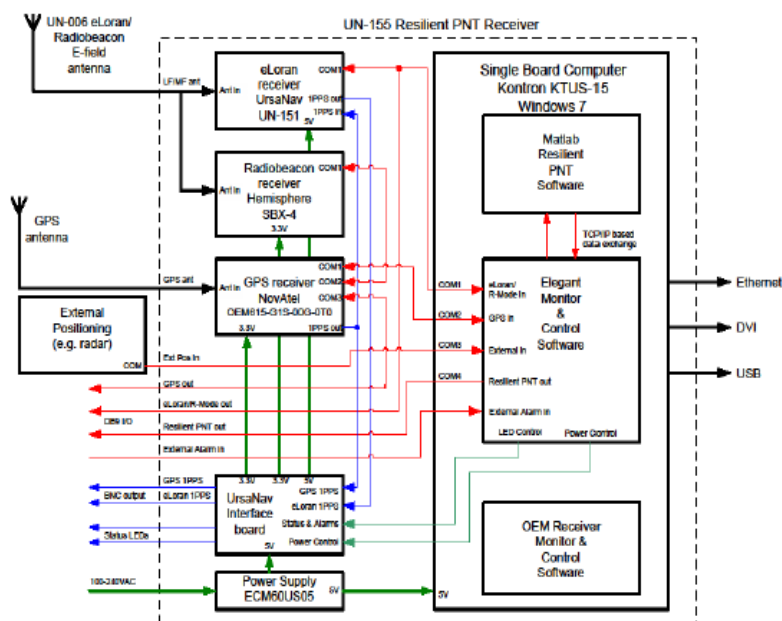

The PNT processor computes a position solution based on TOA measurements from eLoran receivers, as required (also RMode as a future expansion); it stores and applies propagation data corrections (e.g. eLoran ASFs); it applies differential correction data to the pseudorange measurements of terrestrial PNT services; it computes and maintains the Horizontal Protection Levels (HPL) for complementary PNT services and the primary DGPS service – independent performance monitoring; it detects incidents of GPS interference and jamming, and monitors the interference level; it automatically and seamlessly switches the main PNT output of the service to the best available backup source given the prevailing interference/jamming/outage conditions; and it generates alarms for the purposes of notifying the mariner and shore-based stakeholders.

A demonstration was run on the EPD of the *Pride of Hull*. On the EPD (or ECDIS), PNT source is being used and an idea of its accuracy can be seen. It also shows (on the outline of the ship) an ellipse for the accuracy (5m would have a 5m ellipse) around the ship showing the area in which the ship is positioned. If GPS is lost, the EPD shows an alert on which the mariner can click to show that it has switched to Resilient PNT.

The *MV Palentine* is integrating a receiver onto their second ECDIS, so they have an eLoran fallback if they lose GPS. *THV Patricia* has a Sperry-modified ECDIS with a receiver integrated. This receiver has been fully tested and certified and is becoming part of IMO:NCSR, IEC and RTCM standards; though we are currently only integrating PNT receivers into ECDIS, not any other elements of the ship.

Michael Hoppe discussed the R-Mode concept and the study and testing into it.

R-Mode (Ranging Mode) is the transmission of accurate synchronized timing signals from existing terrestrial maritime radio infrastructure. It uses terrestrial radio links which are standardized and already globally distributed for maritime usage, adapting the MF: IALA Radiobeacon Service (DGNSS) and the VHF: AIS-shore based service.

The feasibility study was split into three parts:

- Part 1: Investigation of R-Mode based on existing MF IALA radio beacons infrastructure
- Part 2: Investigation of R-Mode based on existing AIS shore infrastructure (VHF)
- Part 3: Combination of R-Mode Signals from radio beacon, AIS and eLoran transmissions



The results of the study show that the range accuracy for the North Sea Region can have 3m accuracy with good signal using MF radiobeacons and 10-20m accuracy at night. Range accuracy is also good for AIS: depending on region you can achieve 10-20m accuracy. Finally, combining them all (MF, AIS and eLoran) we can provide 10m accuracy in key pinch points of the North Sea:

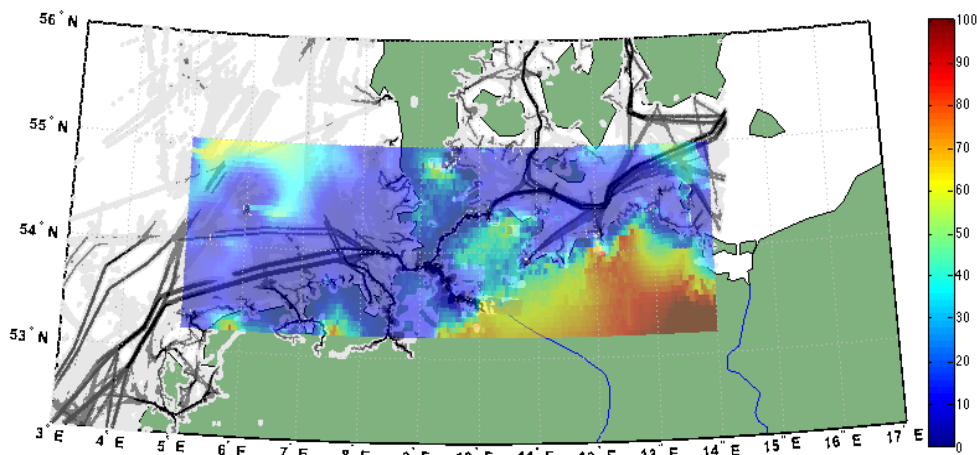

The next step was to build a transmitting site in Ijmuiden and Noordwijk to provide a transmission system testbed on MF. The first measurements were on the 27<sup>th</sup> of January. The results are very encouraging and validate the feasibility study that we could receive better than 5m accuracy.

In conclusion, DGNS R-Mode is a backup to GNSS that can meet the resilient PNT requirements of e-Navigation. To achieve widespread resilient PNT, the best solution is to use all signals available in a true all-in-view receiver. The first on air test results are very encouraging and validates the results from the R-Mode feasibility study. It is important to continuing work on R-Mode to show the full potential of R-Mode as a terrestrial backup system using existing maritime infrastructure

### 2.4.3 Maritime Cloud / Maritime Communications

Thomas Christensen of DMA began his presentation by showing the Maritime Cloud film as an introduction to the solution. The video can be viewed at <https://dma-enav.atlassian.net/wiki/display/MCCT/Maritime+Cloud>

In essence, the Maritime Cloud is a communication framework enabling efficient, secure, reliable and seamless electronic information exchange between all authorized maritime stakeholders across available communication systems.

Where did the concept of the Maritime Cloud come from? It has two sources. The need was derived from trials within the EfficienSea project, where we encountered problems of communications within the prototype e-Navigation services. There was also the top-down need, derived in the IMO strategy plan for e-Navigation.

The prototype was created in MonaLisa then developed further in ACCSEAS. Many services developed and tested in ACCSEAS utilize the Maritime Cloud. Exchange of intended route, Route Suggestion, MSI & NM (T&P) service, Vessel Operations Coordination Tool (VOCT), and the maritime messaging service have been tested with the Maritime Cloud.

Prototype has been running which is supporting various test-beds including ACCSEAS, the MonaLisa 2.0 project, Transas, MARSEC XL as well as the Koreans KRISO and KMOU as part of the global e-Navigation test-bed are using and developing services with the Maritime Cloud.

It will be further expanded in a global e-Navigation test-bed between Denmark, Sweden and Korea. It will form the infrastructure for the new Sea Traffic Management Project and EfficienSea 2, where we will establish a regional Maritime Cloud that is operational throughout the Arctic and Baltic, supporting prototype and operational services.

The vision is that IMO will adopt it as their e-Navigation infrastructure, and also within IALA and ESSCTG (e-Navigation Ship Side Coordination Task Group, the ship-side counterpart to IALA), who it is hoped will make the Maritime Cloud the de-facto infrastructure for e-Navigation.

The workshop will cover a high-level discussions on governance of the Maritime Cloud in the future, liability and trust issues, benefits and downsides of the Maritime Cloud as well as a roadmap for the future development.

#### **2.4.4 Introduction – Route Topology Model for the NSR**

Jan-Hendrik Oltmann presented the introduction to the Route Topology Model (RTM) on behalf of his co-collaborators in the development of this solution John-Morten Klingsheim and Stephan Procee.

The topic is routes in the North Sea Region. The advent of Marine Spatial Planning (MSP) was the trigger event for the development of a Route Topology Model, to be used for e-Navigation applications, which will in-turn support MSP. Through the next presentations we will discuss modes of portrayal, the idea of a generic or instance RTM as well as existing definitions that we have taken on board in developing the Route Topology Model.

MSP explores the issue of making best use of the sea space. With – as was mentioned by Thomas Porathe in Setting the Scene, North Sea Region Challenges Section 2.3.3 earlier – a reduction of navigability in the North Sea Region, how do we effectively plan the maritime space in this region?

The first task was to draw lines for routes in the shipping lanes in the North Sea Region, then identify where the lines meet (junctions) and add important nodes (stopping points). Once done, this you provides a rudimentary and abstract RTM – which holds true of the traffic situation in the region.

The legs and the nodes are the two building blocks of a Route Topology Model. Once we studied further the type of nodes we had we identified junctions and waypoints, where you can change route.

There needs to be a distinction between a generic Route Topology Model and an Instance Route Topology Model. A generic RTM is based on the S-100 framework and is part of the Common Maritime Data Structure. There are many Instance RTMs, one for each sea area under consideration, for example the North Sea Region RTM. We used this notion to build an instance for NSR. We build this to build applications of it to help us understand the picture and mitigate the issues.

In ACCSEAS, a definition of the generic RTM has been written, as well as defining how to define a specific instance using IMO guidelines for voyage planning and IMO SN.1/Circ.289 as well as IEC 62288:2013. The RTM will also be tying into trans-European networks such as the EU Motorways of the Sea, MonaLisa 2.0 and the EU Inspire Transport Networks.

The NSR instance of the RTM has been defined by using AIS data and other data to build a database of RTM data for the region, identifying tables of legs and nodes. We then looked at how it should be portrayed and identified three different modes: ENC/ECDIS mode; London Tube Map mode, which is slightly more abstracted; and finally in a head-up display/augmented reality mode, which will be elaborated by Stephan Procee.

The ENC/ECDIS portrayal layer, using the Motorways of the Sea area of the area of the NSR, was derived from a number of days' discussion. This is to be used in an ENC, it portrays the model in its true topographical context, it can be zoomed and scrolled through, used for navigation but also tactical and strategic voyage planning and optimisation.

An example of the London Tube Map portrayal is below

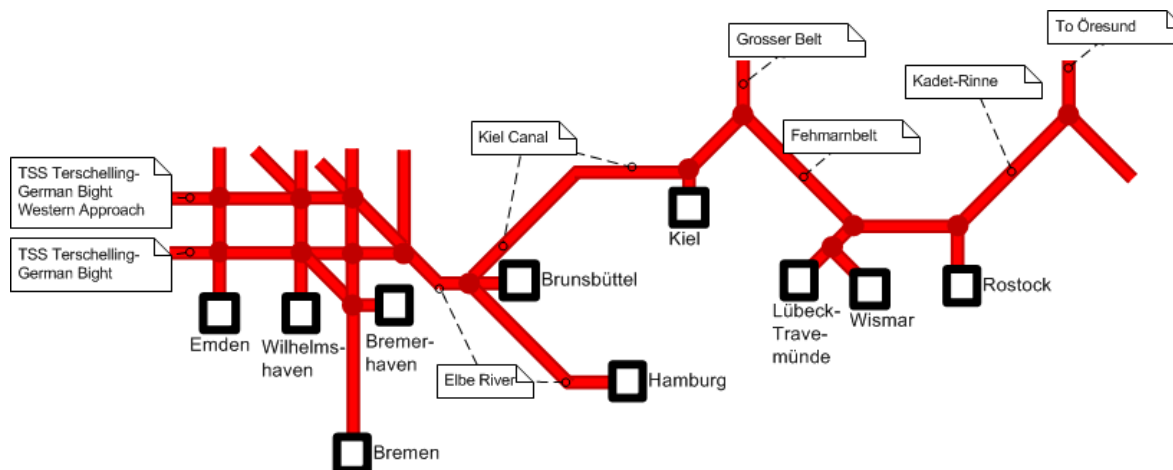

It is the German coast with ports, resembling the geography of the area but reduced to display traffic relationships with individual symbols for nodes, waypoints and junctions.

The Head-Up Display/Augmented Reality portrayal shows features visible or relevant to the individual vessel in a given tactical situation. It creates awareness for up-coming situations regarding routes, such as nodes of relevance (bends, junctions, ports) and allows for a Scheduled Time of Arrival display.

The RTM portrayal modes are being tailored for different applications, including shipboard and shoreside, so that different users can employ them effectively. The applications will also be scalable as required by IMO's strategy for e-Navigation.

Finally, each Route Topology Model (generic and instance) will all be part of the same data model (the aforementioned Common Maritime Data Structure). This is another pre-requisite for IMO strategy – the idea of harmonisation, and it will also help when developing the RTM as a product.

#### 2.4.5 Mariner's perspective on the NSR-RTM

Stephan Procee noted that at the start of the ACCSEAS project there was a request: where do ships sail? The answer to this starts with AIS. Where possible, we collected the accumulated AIS footage for 2012 from each authority bordering the NSR and created a picture of where AIS-equipped ships sail. This picture shows that the collected AIS messages have relations with ships' routes (the purple being traffic separation schemes on the Dutch coast and the pink being the dense AIS messages):



750,000,000 AIS messages were analysed and saw that 50% of the AIS messages were from cells (areas on the map of 400m x 400m) where 1300 messages or more were received in a year – dense traffic. We can use this to see where ships tend to sail and where they don't. We use this to draw a picture of the routes that AIS ships tend to use. See below the routes where more than 1300 messages are received a year (i.e. the most dense traffic areas in the North Sea):

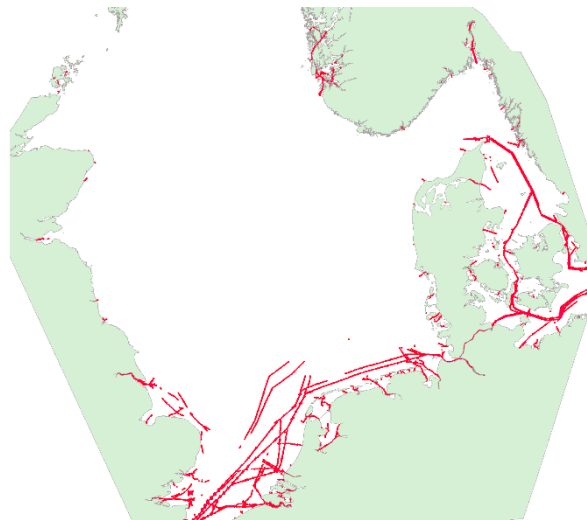

Then more than 800 messages per 400m x 400m cell added on top shows the next level of well frequented shipping lanes on top of the densest areas

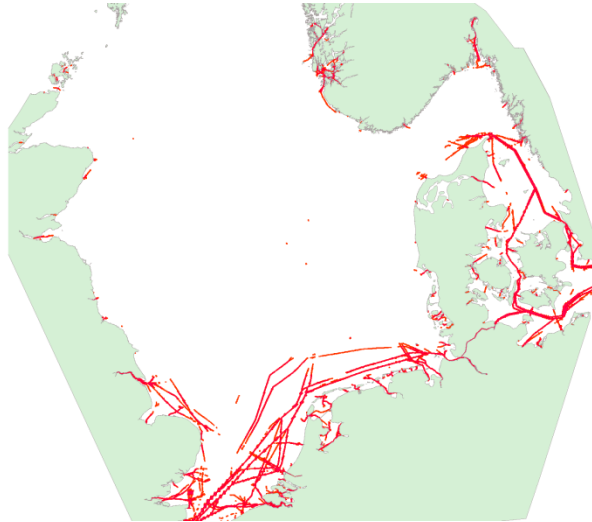

And more than 400 messages (the lighter shade)

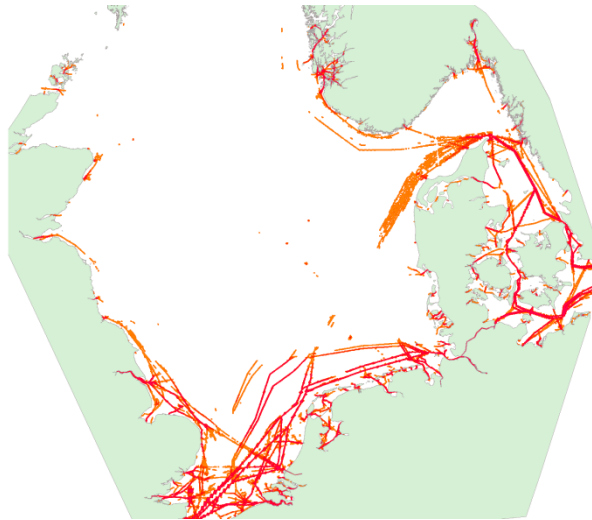

Down incrementally in shade until you begin to see a clear picture of where ships tend to sail in the region

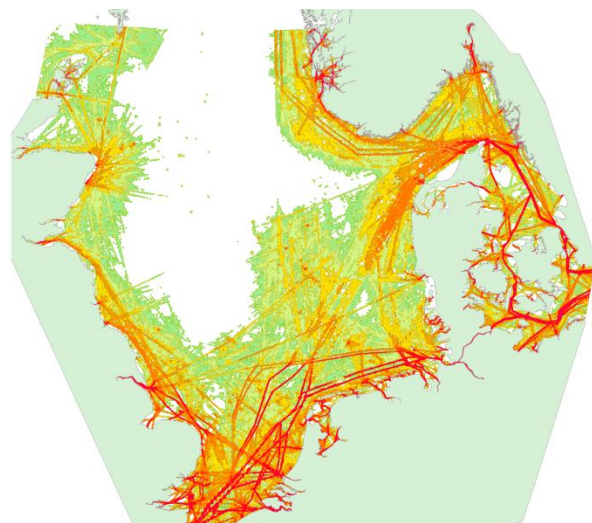

This data can then be used to draw a more simplified picture of routes that appear to be used by AIS ships:

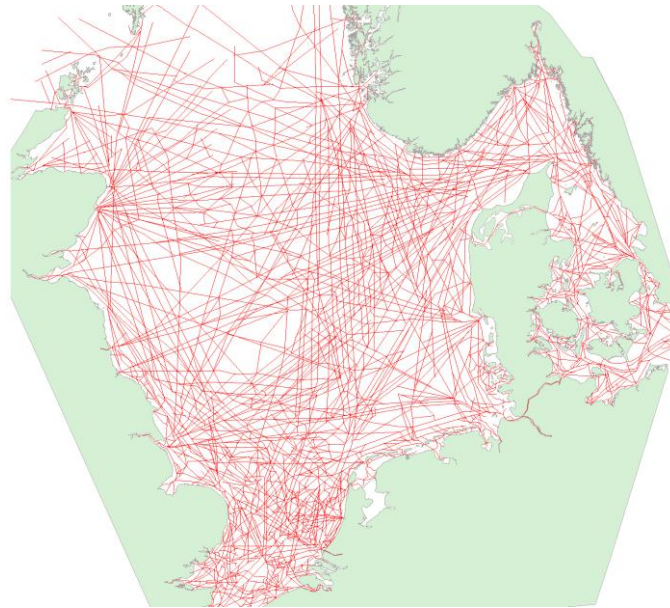

These routes can then be further analysed, for example finding out the shortest paths between each port in the region (below, in black):



This shows us that ships are using routes that are not optimal (the remaining red lines in the above). This needs more development but gives us an idea that although ships are free and have an incentive to use the most efficient route, they are still using less logical routes. Meaning the mariner may benefit from receiving more logical route suggestions. It can also give a topographical idea of where you are on your route and your scheduled time of arrival.

There are a number of benefits for the mariner for using a RTM. Ships sail along routes defined by the model and (auto-) report at nodes and junctions this can lead to transparency for all stakeholders in the logistic chain, including the possibility for strategic planning for safety and estimated time of arrival (ETA). With a more accurate ETA the vessel can sail at a more efficient speed, improving cost-effectiveness for the operators and less waiting time outside of harbours. Furthermore, this will help to use optimum route planning for mariners not familiar with the region.

R.Adm Nick Lambert asked whether, when devising this model, bathymetry, ship size, weather, tidal or other data was taken into consideration. Answer: for this top level model it was not required but if you wish to have data and optimal routes for ships of your

characteristics there is no reason why it could not be included, it requires further development.

#### 2.4.6 How NSR-RTM may support vessel traffic flow throughout the region

Jan-Hendrik Oltmann pointed out, at the start of his presentation on the shore-side perspective of a RTM, that all discussions related to this subject will be captured in an RTM Description document which is in the process of being drafted.

This session aims to discuss the maritime Trans-European Network (TEN) in the North Sea Region; it aims to model different classes of shipping lanes; and to show how the knowledge gained from a NSR-RTM can benefit traffic flow.

TEN-T (the EU Trans-European Network) Motorways of the Sea documents have maps with drawings on of key routes (or motorways) in the North Sea. They appear to be artist's impressions that is under-developed and misses key areas of the routes in the region. The North Sea Region RTM as already discussed can fill in the missing gaps for Motorways of the Sea, providing nodes and legs and the complete shipping lanes in the ENC portrayal.

In the TEN-T network, this detailed map of the land-side infrastructure is available.

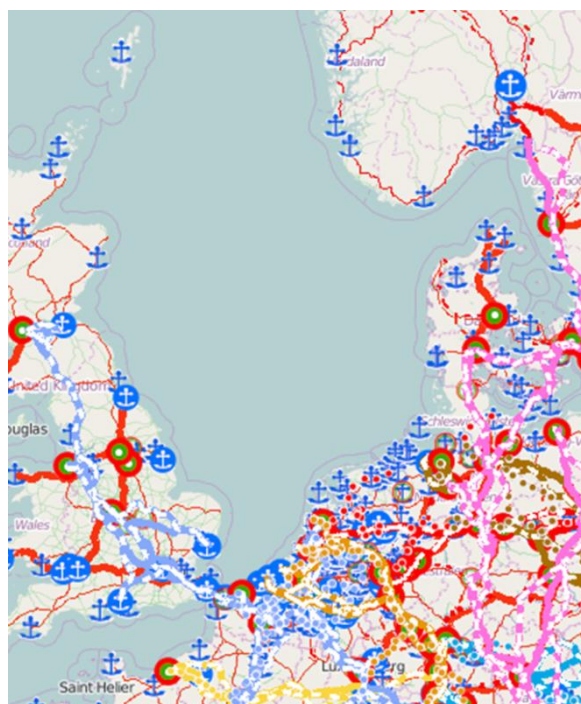

However, the North Sea is not mapped with a network. Here the Route Topology Model can provide a similar infrastructure for the sea such as:

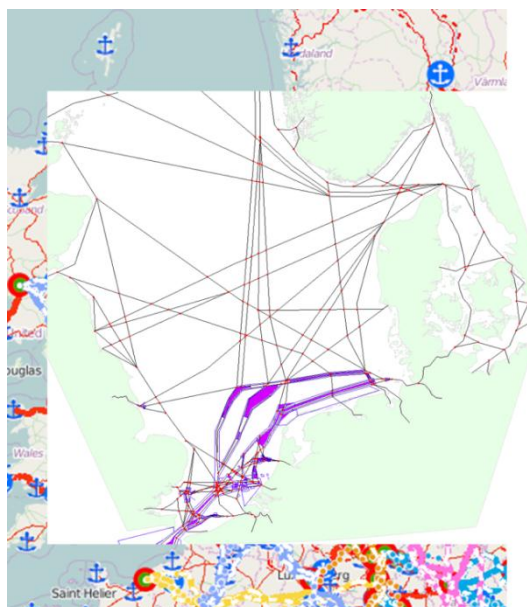

The above image would be what we can class as the man 'motorways' in the sea – but how do we take into account the other lanes in the sea within the TEN concept? One proposal might be other classes of shipping lanes, for example a 'Road of the Sea' – lanes relevant for professional and commercial shipping; and a 'Trail of the Sea' – all other lanes, in particular those only available to small crafts.

There are benefits to this model for traffic flow. It will support VTS to understand where all the vessels are and when they will meet in a simplified portrayal mode, which will be easier for de-conflicting information. It will also give more precise estimated time of arrival (ETA), causing increased efficiency, not to mention cross-sectorial transparency in the logistics chain.

The RTM can also help optimise the availability of e-Navigation Maritime Services, by making them available when a vessel reaches an appropriate leg or node of a journey for example, or making relevant solutions available depending on whether the vessel is taking a motorway, a road or a trail (as per the above description), thus more effectively tailoring services to the needs of the vessel.

#### 2.4.7 NSR-RTM as an ACCSEAS legacy for Europe

John-Morten Klingsheim discussed the RTM in terms of its potential future use in Europe, in terms of the INSPIRE directive, ITS, Intermodal Transport and Maritime Spatial Planning.

As mentioned by Jan Hendrik, the TEN-T transport network does not take into account the North Sea as part of its map – the RTM can supply the information for this which will be beneficial for maritime stakeholders working in the framework of TEN-T.

The INSPIRE directive from 2007 is the first step to establish an intermodal transport network within the EU, requiring all member states to have an infrastructure for spatial data and provides a model for legs and nodes which has been followed in our development of the RTM. But, of course, the RTM can be used for a lot more than just navigation.

One major issue is that this needs to be connected cross border, connecting nodes between countries – which means nations have to agree on these connections. As an example, Norway has its own planning internally for its logistics but it does not take into account ports and shipping because the logistics are international.



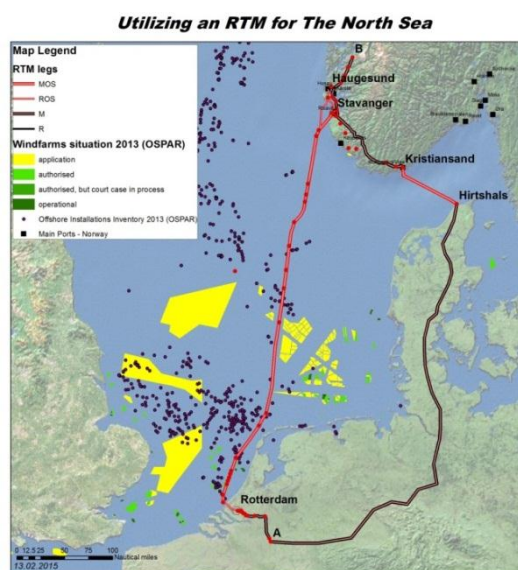

In the above image, you can see two options to get from Rotterdam to Norway. If we used an established RTM we could have options, add information and options for the user, such as ETA and options between modes (such as when a ferry connects and other time-sensitive issues). The RTM can be used to safeguard areas within Marine Spatial Planning that are for conservation.

Route Topology Modelling (RTM) appears to be an abstract but promising method to assist in solving several issues identified for a vessel's voyage and for vessel traffic flow. The Workshop will elaborate on ideas and topics presented in the preceding presentations by discussion and gather views of stakeholders present.

## 3 Day 2

### 3.1 Review of workshop results

#### 3.1.1 3rd North Sea Region e-Navigation User Forum: Maritime Cloud

Thomas Christensen recapped the lively discussions at the Maritime Cloud workshop.

The workshop started out by providing more detail on the Maritime Cloud than was in the short presentation. We then opened the floor to questions. It was an opportunity for those present to fully understand what the service was about, and it enabled us as developers to pinpoint the less clear areas of the concept, as well as challenges on the way to realising this as the infrastructure for e-Navigation.

The topic of governance of the Maritime Cloud was discussed, the need for a body to be responsible for identity registries and service portfolio registries. Additionally, regional servers are required and someone to manage them.

The issue of liability and trust was discussed, the Maritime Cloud relies upon the ability to exchange critical and confidential information securely. We also discussed how this service fits in with the S-100 standard, and how will it fit with different service providers (safety, commercial etc), and will this be tracked in cloud? Additionally, it was agreed that more detail is required on how we manage services – what if you have two services providing the same solution but to varying qualities.

### 3.1.2 3rd North Sea Region e-Navigation User Forum: Resilient PNT

GNSS (of which GPS is one example) is the primary source of electronic navigation information in use today by the mariner. But GNSS is vulnerable, to intentional and unintentional interference, system failures and solar effects. Many ships' systems rely on electronic position fixing; ECDIS, radar, GMDSS, gyro calibration etc.

If the mariner is to take full advantage of e-Navigation services he/she will need to be able to rely on electronic Position, Navigation and Timing information for own ship location and situational awareness. In this way we build in "resilience to electronic position fixing systems", just like the IMO have asked.

In this workshop, this important requirement was presented, and allowed participants to present their views.

During the workshop, the ACCSEAS Multi-Source Positioning Service video was shown, which was filmed on board the P&O Ferry Pride of Hull (it can be watched here: [https://www.youtube.com/watch?v=SI4sMgP4\\_qs](https://www.youtube.com/watch?v=SI4sMgP4_qs)), where the demonstration of the Multi-Source Receiver took place in October 2014. This video facilitated and generated discussions and was a means of showing what ACCSEAS has achieved.

Summary:

- The workshop was well attended by around 35 people.
- The attendees were shown the MSPS video which helped show what ACCSEAS had achieved and start the discussions.
- There was a general interest in what resilient PNT could do, how it could be achieved and what it may cost. It was recognised that all of these things will be dependent on user needs and the complexity of the solution, but that costs would reduce with market forces. Different solutions may be required for different locations and this is down to the service provider.
- The workshop discussed a number of different points, including some of the more technical aspects of resilient PNT, such as integrity, decision algorithms and how the different elements are integrated.
- The workshop reviewed GNSS outages, from which it was noted that events do occur and happen relatively often around the world, and that it's often difficult to know who to tell.
- Where we go in the future was discussed along with standardisation activities, including the draft performance standards being considered at the IMO NCSR and integrity equations being developed as part of RTCM SC127.
- Overall the workshop was a lively, open and worthwhile discussion on the different aspects of resilient PNT and we'd like to thank all of those who took part. A more in-depth summary will be included in the conference report.

### 3.1.3 3rd North Sea Region e-Navigation User Forum: Route Topology Model

The workshop was led by Jan-Hendrik Oltmann and asked four key questions about the Route Topology Model (RTM). The various answers and discussion points are listed below each question.

The first was what is the potential of employing a RTM in the NSR and beyond? The feeling amongst the workshop was that a RTM has potential but it depends on the situation. For example vessel type may have an impact of optimisation times. There may be a difference in terms of just on time arrival for container vessels or bulkers, or do they even require it at all.

It was recognised that pilots in Skelde have already established an RTM based on AIS, which brought about the notion that standardisation of these models will be important for scalability and that everybody is speaking the same language. Sea conditions and weather

data will be important when applying the model to assess how stable the routes are and to ensure a contingency plan in certain weather conditions. The routes may change depending on tide and we need to represent this in portrayal.

Question 1: What potentials of employing RTM are there for the NSR and beyond, considering in particular European initiatives like e-Maritime, Motorways of the Seas and INSPIRE?

- RTM has “a lot of potential“
- There was an issue raised with port authorization for ULCC (Ultra Large Crude Carriers – one of the longest types of vessel); there are “too many large vessels arriving” – the RTM could help address this;
- RTM has a role for port traffic management;
- Pilots in the Skelde region have established their own RTM already and use incoming AIS data (as soon as they are in reach of an AIS data provider);
- We are making assumptions to where the ships will be, which is potentially misleading;
- The RTM is “connectivity with the brain of the mariner”;
- As soon as they are in touch, it would be desirable to have a constant stream of dynamic route and ETA updates from vessels for the benefit of the Port Community System;
- It is important to exchange a maximum of data between ship and shore, so that the other side may use that data at their discretion; this is better than keeping data at its origin. Demand for this will increase with the advent of the “internet of things”;
- Standardization of RTM formats would result in an improved mutual understanding of the routes (by common designators and commonly known features) which would be helpful;
- Current and weather data should be applied to the routes as well;
- A potential incentive for shipping to participate in the RTM: talks with major ship owners have indicated that optimization of departure, i.e. punctuality of scheduled departure, is more important than arrival punctuality. Being late is not considered bad as long as it is known (in advance);
- There is a big difference in the requirements in different sectors of shipping, i.e. differences between bulk carriers and gasoline carriers;
- The trade-off between capacity and predictability needs to be taken into account;
- Influence of tide on RTM: how stable are the routes? There can be a stable RTM as long as all possible options (including tidal-dependent variations) have been included. The dependency of certain legs/nodes on sea conditions needs to be mapped into their attribute domain. When using RTM data there should be some contingency planning;
- Clarification is required on the data sources for the construction of an instance RTM: TSS, depth information, port of destination.

The second question was how can the RTM contribute to Marine Spatial Planning? The potential of an established RTM to assist MSP was recognised; as soon as we have such a model we know where ships sail and where they should and could sail. One person noted that there is a natural development that shipping will take place only in pre-defined routes, and defined routes will help us to protect our interests.

Question 2: How could employing a RTM specifically contribute to solutions for issues introduced to shipping by Marine Spatial Planning?

- The potential of a RTM, once established, to influence Marine Spatial Planning was recognized;

- It is foreseen as a natural development in the NSR that shipping will take place more or less only in pre-defined routes (whether protected by TSS or not) due to the advent of MSP.

The third question was what are the relevant user requirements for the graphical display of an RTM (ENC, London Tube Map and Augmented Reality)? For ENC passage planning for the mariner would be helpful. It was noted that all portrayal modes have a place in different conditions. It was recognised that human-machine interface should be supportive of re-planning of schedule throughout a route. Exchanging plans will be needed – ship-to ship and ship to shore and updated so that each party has the up-to-date route. This requires a strong communication infrastructure.

Question 3: What would be the relevant user requirements for the graphical display of RTM data to become meaningful information in the three portrayal modes for RTM (namely ENC, London Tube Map, and Augmented Reality/Head-Up Display)?

- For the mariner's passage planning, ENC mode (implemented in ECDIS) was considered useful - at the planning station;
- "All modes of portrayal have got a place" under different conditions; human-machine interfaces (HMIs) need to dynamically adapt the display mode based on context;
- The usefulness of re-planning of a schedule at port would be supported by a RTM HMI on the ship;
- There is a need to deal with the uncertainties of information exchange of RTM data.

The fourth question was what should be further explored after ACCSEAS? The integration of the RTM into e-Navigation; adaptable advanced route planning; the relationship between routes and collision avoidance; the difference between strategic and tactical use of RTM needs to be further considered; and finally an overall assessment of the safety impact of RTM needs to be conducted.

Question 4: What RTM-related topics should be further explored after ACCSEAS?

- The integration of a RTM into "e-Navigation";
- Adaptable advance route planning;
- The relationship between routes and collision avoidance: can you introduce wrong behaviour due to route designations?
- The difference between the strategic and tactical uses of RTM;
- An assessment of the impact on safety of a navigational use of the RTM.

## 3.2 ACCSEAS e-Navigation test-bed solutions (cont.)

### 3.2.1 Maritime Safety Information and Notices to Mariners (T&P) service

Thomas Christensen returned to the podium to discuss the Maritime Safety Information and Notices to Mariners (T&P) service (or MSI/NM service), which he described as one of the most obvious solutions for e-Navigation.

MSI/NM is prioritised in the IMO as a prioritised solution. The project has taken a top-down view on how to do it, to start from scratch and rethink how to deliver it. MSIs and NMs are similar but different in the communication channels they use to promulgate information. Often, thanks to them you can get the same information but through different channels, which can be confusing if, for example, one is updated faster than the other – which do you choose?

How are MSI/NMs currently promulgated? The services geographically identify parties who are relevant for it (and some more as a safety net) and sometimes not all, and are delivered on paper. We may or may not know if the parties have received the information.

What is the better way of doing this? We can use the Maritime Cloud (MC) to target those people who are relevant for the information, using a choice of communications channels, and then receive an acknowledgement once it has been received. This gives us quality assurance.

The user will see the notice as part of their navigational system (ECDIS) and it will be overlaid on their chart like the below:

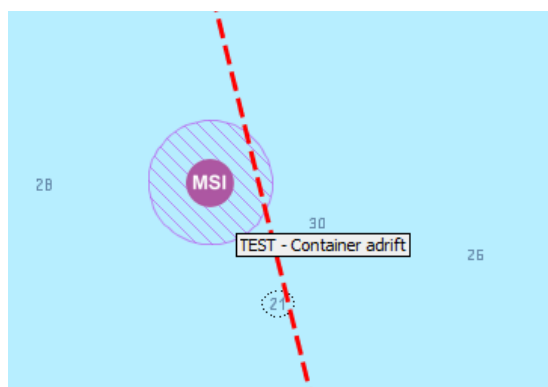

We envision adding on a mechanism (using the MC) to the current ways of transmitting MSI/NMs so that capable vessels can receive it in this new way but other vessels will not be left out. We have drafted an S-100 data model to the extent it is possible.

The project has tested this draft model in the NSR. We developed a system for entering and monitoring data, as well as a system for communicating it to the EPD on board the ship. We had end-users testing it on the ship and service providers testing the system from a data-entry and management perspective, with a prototype editor software that can administrate, enter and edit information.

Positive feedback has been received from users (Mariners) and coordinators (National Coordinators and Hydrographic Offices). There were two main concerns on the combined model:

- History – not how information is organized or handled today
- Organization – information handled in different organizations

We hope that there will be a GMDSS Review, where we can include thoughts on the possibilities for promulgation of MSI/NM in the near future. We also hope that we can generate a new S-124 standard, and we really appreciate the huge efforts from the IHO S-124 coordination group.

The next step is to input our findings and data models into the relevant bodies; IHO, IALA and others. We aim to participate in the S-100 work and develop the MSI/NM editor and model further (including WMO/weather warning as part of the MSI). The MSI and NM will continue being a key part of the development of e-navigation and the results will be used in future projects, including EfficienSea2.

### 3.2.2 Tactical Route Exchange (Route suggestion / Route exchange)

Anders Brodje presented Tactical Route Exchange, both intended route and route suggestion.

Intended route is where the mariner makes part of a vessel's planned route available for other vessels to see using the ECDIS. This can include their current position as well as a

number of waypoints ahead, i.e. only the aspect of the route that will be relevant to the vessel you are sharing with. This route is based on the already existing voyage plan (as required by SOLAS) that navigators normally already plot in their ECDIS. The solution will use the Maritime Cloud or AIS for transferring the information.

Route suggestion is where the mariner makes vessel's planned route available for VTS in order to better plan a passage through a VTS area. Similar to intended route this is based on the already existing voyage plan (as required by SOLAS) and normally already entered into the ECDIS and would use the Maritime Cloud or AIS. The VTS can also suggest a different route electronically to the one the vessel is intending to take, especially when there is an issue with the existing one. This can be to make the passage more efficient and safe.

These concepts were initiated in the EfficienSea project and augmented in ACCSEAS and MonaLisa 2.0.

The aim is to improve situational awareness. Situational Awareness was defined by Mike Endsley as "The perception of the elements in the environment within a volume of time and space, the comprehension of their meaning, and the projection of their status in the near future".

The concept of Situational Awareness is based only on one person. However we are looking at multiple and distributed operators: the officer of the watch, the captain, chief officer, the navigator as one team; then the people at the mooring station are another team; the VTS is a third; the tug operators are another. In this situation, we have team of teams, all of whom need to be Situationally Aware. This leads to the requirement of a Shared Situational Awareness – requiring each team member to have enough situational awareness to complete their task.

Because each team involved in the operation has a small overlap in their tasks (for example a vessel, another vessel and the VTS operator have only a small overlap in their tasks), each team requires more communication between them to improve their shared situational awareness. Exchanging routes is a way of communicating this information.

Within ACCSEAS, trials of Tactical Route Exchange were set up, using all concerned parties in real and simulated environments. We used pilots, mariners and VTS operators in several scenarios and conditions before surveying their responses to the solutions.

The results of the survey were very positive with 100% of those surveyed saying the solution was good or very good and that it assisted verbal communication between vessels, supporting an increased Shared Situational Awareness between vessels and vessels-VTS. One participant was heard saying, during a trial, "There is something wrong with the system, I can't see the route for that ship!" noting that users were keen to see routes for other vessels as well in the simulated environment.

Similar results were found for the trials of Route Suggestion, with 100% again saying that the concept was either good or very good, commenting that it supported verbal communications between the mariner and VTS. During the trial one of the VTS operators explained the route he was suggesting, then he said "I'll send you the route suggestion so you can see what I mean". The solution very quickly became a visual tool for aiding communication, with the added bonus of mitigating language difficulties.

In conclusion, Tactical Route Exchanged (Intended & Suggested Route) was found to increase shared Situational Awareness between vessels and between vessels and VTS. The services are ready for deployment and will be included in the updated ECDIS standard later in 2015. This will mean that it will need to be incorporated into ECDIS training.

### 3.2.3 Augmented Reality

Stephan Procee returned to the podium on Day 2 to talk about the Augmented Reality Head-Up Display concept.

We have discussed e-Navigation information, but we are yet to explore new ways of supporting and projecting it to the mariner in a harmonised and standardised way that can aid situational awareness.

The question, "why we seem to dislike humans?" was asked. It is often the human factor that is explained as the reason for collisions, and so we introduce more technology to remove the humans. However, the more automation we have, it is still the user that is running the machine. So it is important that we make sure the technology is right for humans.

Take the image released by Rolls Royce of a futuristic ship bridge



In this image you can see a version of augmented reality on the screen – displaying the ship's route, speed and other characteristics as well as the characteristics and routes of other ships.

Imagine this, not uncommon, scenario: a second officer, after having done the midnight to 04:00 watch, starts work again at 05:00. He navigates the ship as it is entering port and berthing, opening hatches at seven. He has breakfast, receives port state control for an inspection of safety equipment, and eats a hot meal at 11:30 before starting watch again at midday until 16:00. After that he does his administration, has a short supper at 17:30, assists hatch closing and un-berthing at 19:00 and is able to rest a few hours after leaving port. His next watch commences at 00:00.

So, after that busy 24 hours he is back on watch and at 01:45, with a new moon, rain and poor visibility he is leaving the traffic separation scheme at Vlieland Junction in the North Sea. He notices a westbound container vessel on starboard side, a supplier astern and some fishing vessels ahead – and suddenly there's a collision warning on his screen! He needs to know which vessel is causing the issue and how to mitigate it without causing a potential collision with the other vessels in his vicinity. This takes valuable time to find out.

Wouldn't it be great if we had a way of simplifying these complicated situations for the mariner? Would it help if the watch officer was provided with a visual clue about the direction of the dangerous target? Would it help if the watch officer had this clue in a head up display, showing the real outside world together with a synthetic marker on top? This would speed up detecting the target and starting evasive action. Of course the watch officer should always be alert. They should always react in a timely way and comply with collision regulations.

What could we include in this overlay on top of the outside world?

- Position, course and speed of own vessel
- Position course and speed of target vessel

- An algorithm calculating relative distance and direction
- An algorithm to discriminate targets and generate an alarm
- User-requirement input/control, defining what will generate an alarm (alarm threshold)
- Input from external information – VTS etc
- Take into account the position of the officer on the bridge to make sure that the overlay overlaps correctly with the real world
- Means of presenting this in an augmented way

This display could also include routing information, such as route suggestion; safety information, like MSI; weather information; ships' control information; virtual binocular with the aid of a multi spectral band camera.

This was how the concept of augmented reality goggles was devised.



In these goggles, there are two lenses, through which you can see 70% of the outside world and 30% of the synthetic picture. The synthetic overlay will look something like this:



With the black background replaced for the view outside the goggles. This picture includes heading, AIS information and other symbols with colours based on urgency.

Mr Procee's personal experience is that the brain needs time to adapt to it the goggles. It will require training, and needs to be made more comfortable for the user than the prototype you can try today. We showed this solution at SMM in Hamburg, including to some old



mariners who were suspicious of technology on the bridge. They were very positive about it. Eventually we envisage transparent touch-screen monitors being used on the bridge.

There are still issues to solve with the prototype. We have to correct for roll, pitch and heave; correct for the position of the watchkeeper (parallax effect); there are issues with the reliability and accuracy of third party information (AIS); we could add an integrity check by means of RADAR and there are human factors that still need to be assessed over a long period – we need to understand how this will change the behaviours of the watchkeeper, and how can we make sure they are taken into account.

We can combine the augmented reality into a number of solutions: tactical route exchange, no-go area, route topology model, Resilient PNT and the maritime cloud.

### 3.2.4 Q&A Session

Thomas Christensen, Stephan Procee and Anders Brodje formed a panel to be asked some follow-up questions about their presentations.

Nick Lambert commented that some of these solutions (MSI/NM included) are ready and have been very much welcomed by the users who have tried it. Is there a way we can fasttrack some of these capabilities so that the user can benefit now?

Thomas Christensen noted that we're doing what we can to fasttrack MSI/NM. We have setup something called the ArcticWeb (<https://arcticweb.e-navigation.net/>) platform and intend to do the same the Baltic Sea. This platform will have MSI and other information on it that ships using the area can access. One of the shortcomings is that it will be used by a PC on the bridge with unspecified internet access – not an ECDIS or other dedicated display. For the short term this is what we're working with, we are making it available, getting the framework ready shore side and getting the functionality built into existing equipment.

Nick Lambert followed-up by noting that there are some people in the audience who can help us to do this. To which Kees Polderman responded that this is a key point for the conference – how do we further the ACCSEAS project in a global way. We have to find a smart way to offer this without any problems with international organisations. We will pick this up in the workshops.

Wim van Buuren of the Dutch Pilot Organisation asked why we aren't using Resilient PNT already and who is going to take the initiative to set it up. Then asked Thomas Christensen: is MSI/NM going to replace of Navtex and if so how do we take care of the leisure craft users?

Thomas Christiansen: I think it should and it will take the place of Navtex – which is an outdated way of doing it. These mechanisms will have to run parallel for a long time in order that we are not missing anyone out. The solutions we are proposing should also be available to small craft users. Anders Brodje noted that we are covering the leisure craft users in other projects as well.

Mr van Buuren asked a question to Anders: you had a route suggestion projected and I saw that this is leading to a shallow area. Is there an initiative in your project to deal with this?

Anders: it is still up to the navigator to decide whether to take the route the VTS has suggested. The navigator would get the route verbally first then visually. This would also depend on the vessel and is covered by the No-Go Area service.

Erik Verschoor from the chart agent Datema noted that T&P information is available digitally via T&P services and can be inputted into the ECDIS already. The issue appears to be shore-side, where the distributors of the T&P information are not distributing it digitally. Is there need for a new channel as it is already possible just not done?

Mr Christensen: the MSI is currently not formatted in a way to facilitate the information geographically. In the cloud we are envisaging you will not always need the internet connection – in the registry you can see that – which makes it more robust.

Francis Zachariae, Secretary General, IALA thanked the presenters and noted that what has changed in the last few years is that we are now creating results that are now available for the mariner. We are moving beyond the conceptual to actual, valuable results. The big challenge now is to harmonise within the big organisations (IALA, IMO etc). Creating value is important and we are now doing it within IALA.

Wietse Nieuwland, Lecturer at STC in Rotterdam: in the MSI/NM solution I noticed a lot of text. One of the troubles we are seeing in ECDIS courses is that text has to be inputted into charts manually, which is time-consuming. Is there something in the S-100 to simplify or symbolise this?

Anders commented that it is currently being done in the IMO SIP.

Ringo Lakeman of the Netherlands Ministry of Infrastructure and the Environment asked a question to Anders: in order to make a reliable Route Suggestion it is imperative that all ships in the area take part. If you have three and only two are showing their intention and the other isn't. How do you anticipate this challenge?

Anders noted that we have discussed this issue and this will be the situation for a while. The results of the trials have shown that, as long as we continue to have the outlook of route exchange as an additional tool and not an essential tool it will mitigate this. Thomas Christensen added that the value is there with some participants but it is much more evident when everyone is on board.

A Dutch Pilot had a suggestion about a route exchange project, which MARSEC XL are interested in, where route exchange is initiated initially for port arrival optimisation only.

Anders Brodje noted that this is being done in MonaLisa 2.0. That project is looking at strategic voyage management and dynamic voyage management, and it will be similar in the forthcoming Sea Traffic Management project.

### 3.2.5 No-go area Service

Thomas Porathe discussed the No-Go Area service, beginning by illustrating it using the Ovit grounding on the Varn Bank in 2013. The tanker has a draft of 7.9m and the bank has a depth of 2m. Here is a picture of the route on a map:

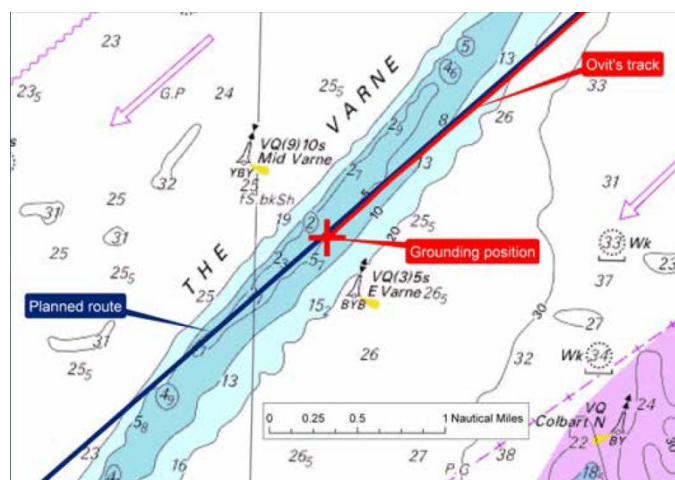

As you can see the planned route went over the bank on which they grounded, and the depth levels were clearly marked.

On the ECDIS you can add a safety contour – which as per factory settings was 30m – this is odd for a 7.9m ship and maybe they never changed it – doing away with a warning. The users also never activated the grounding alarm, so in this instance there were no alarms to warn the navigator that this was going to happen. In conclusion, we created complex technology that people do not find usable and so skip, causing issues such as these.

The No-Go Area aims to help with these issues. It is a simplified way of producing a depth warning, taking into consideration tidal info, draft, and a customised under-keel-clearance allowance.

Technical description:

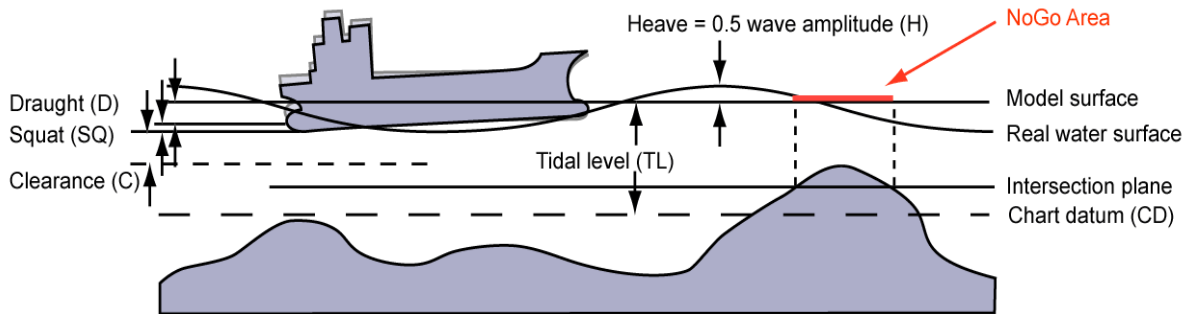

$$\text{Depth of the intersection plane} = \text{TL}(t) - D(t) - \text{SQ}(v) - C - H(t)$$

Potential visualisation on ECDIS:

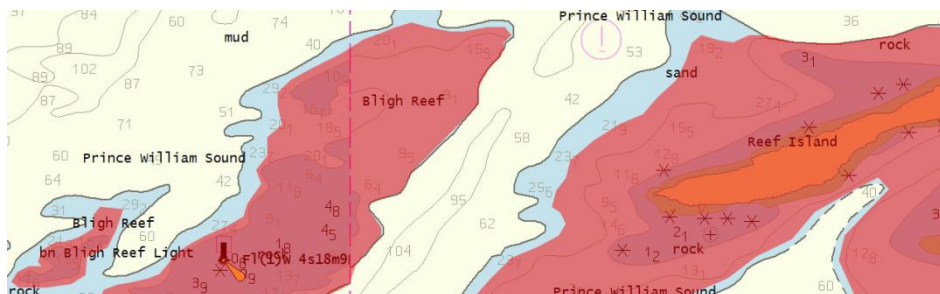

One of the drawbacks of ENC's is that you can only use pre-programmed safety contours as per the hydrographic data. With the EPD, access to this detailed information for depth and time gives for more specific requirements.

We tested this in the Humber Estuary, a very difficult area with shifting sandbanks. For this reason, they continuously survey and produce a PDF report of the data which is only one or two weeks old. The problem is that this is not in the ECDIS. However, for ACCSEAS, we had a database of this data and we inputted it into the EPD (e-Navigation Prototype Display) registry.

To access this information you would send a request with the details of your journey (time, duration) and ship information (draft, UKC). The system computes and overlays the no-go area specific to your vessel at this point in time taking into account the tidal situation:

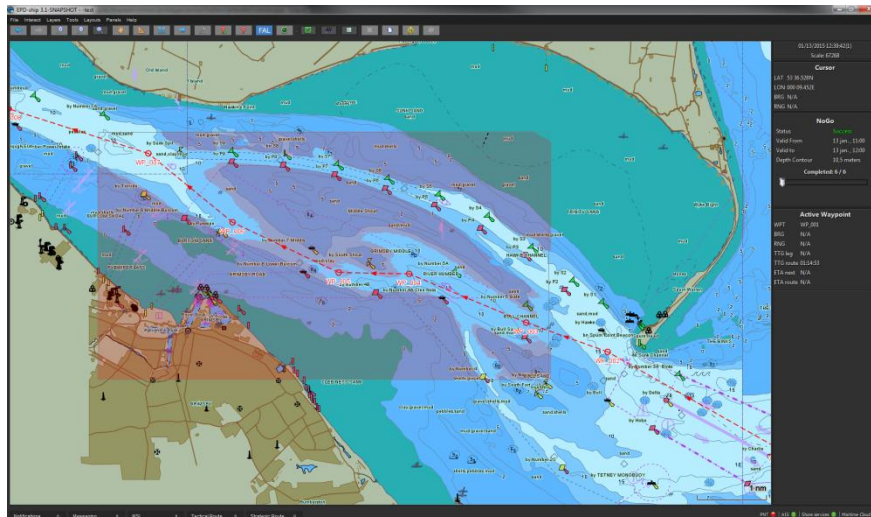

In a perfect system, this will be done automatically as you plot your route – so one hour ahead in your journey you will see the picture then. This is what we aim for in the future. The VTS can use this now as vessels approach.

This was tested in the same situation as the Route Exchange scenarios. We used bridge simulators for 2 ships and VTS at Chalmers University and 11 professional British, Swedish and Danish bridge officers, a harbour master, pilots and VTS operators with experience from traffic in the Humber area with a range of experiences.

Observations and feedback on a conceptual level:

Connectional	Procedural	Functional	HMI
Facilitated VTS / pilot & OOW communication Gave VTS / pilot extra confidence	Lessens workload of VTS / pilot – reduced time explaining tidal situation Less VHF radio traffic to VTS asking for gauge information	The NoGo areas should be automatic along a planned route There should be an alarm for entering NoGo area	Complicated, too many clicks – needs to be further simplified & automated

All bar one of those surveyed said it was a good solution, they all thought that the concept would become a reality in the future.

### 3.2.6 Inter VTS Exchange

Jeffrey van Gils presented the Inter VTS Exchange Format (IVEF), summarising it as a way of not only sharing the common traffic picture between shore-based users but also with ships. This would provide in a powerful tool in support of traffic management and search and rescue operations. There is also potential to share this information across borders, helping national VTS centres to monitor once a ship is outside its coverage and territorial waters. It can help port-entry procedures because centres can see smaller vessels earlier. Most importantly this solution will decrease communication errors and make information more reliable and harmonised.

The accessibility of the North Sea depends on reliable and accurate information about the region, including where the oil rigs and windfarms can be identified and what the intentions of ships are. By exchanging all available information onshore and ship side a better and more accurate picture of the North Sea can be accomplished. For this demonstration, the Dutch Coastguard system and the Government vessel Barend Biesheuvel was used.

If you have the coverage from more than one nation put together you get a good picture of the sea (blue area shows coverage):



Then add in the coverage you get by including the radar picture from ships in the region:

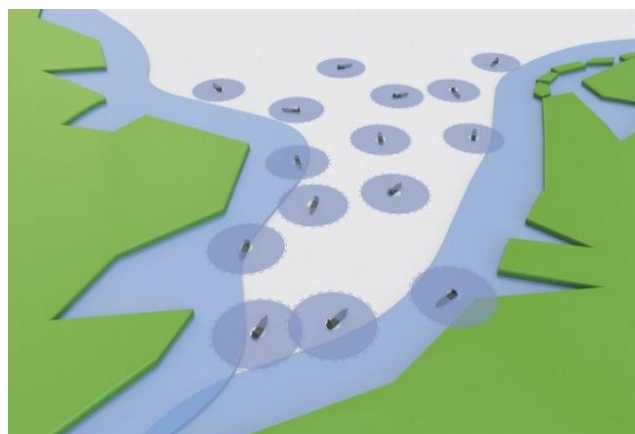

A more complete picture of the ocean is obtained, improving situational awareness for all users and resulting in a better picture of smaller vessels in the region who are not communicating with VTS.

We used as much already standardised and/or realised functionality as possible to accomplish the sharing of the data and show the users possible benefits of the system.

Below is the image of a VTS centre's ECDIS before and after being IVEF-enriched. Before on the left and after on the right

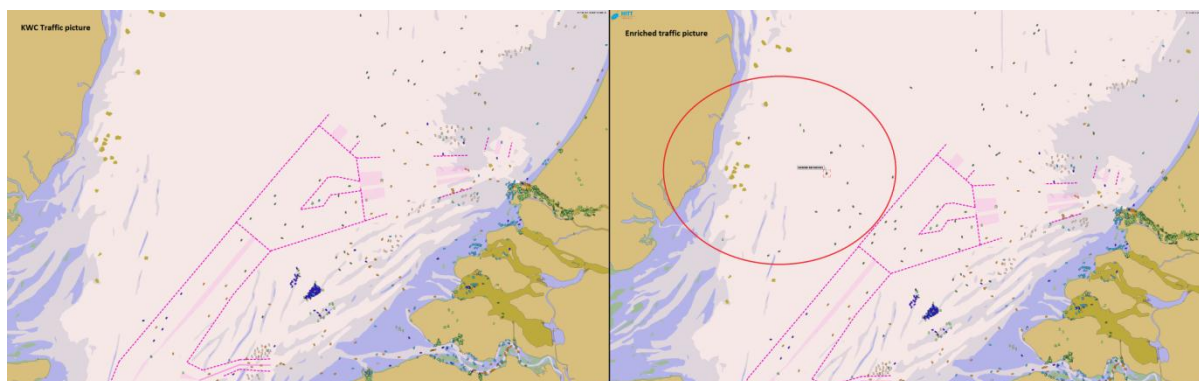

You can see increased information about smaller targets and improved situational awareness.

Reactions from users, ship side:

- Verified targets and additional information;
- Extended coverage (better planning);
- Drifting buoys or other drifting material.

Shore side:

- Verified targets;
- Better view on small targets;
- Backup or extension fallback solution.

In conclusion, IVEF saves money on installing and maintaining sensors like radar and AIS stations; gives the possibility to verify your data with data of partners; allows you the opportunity to track smaller targets from shore; help you to share a common harmonized picture over a specific area with partners (shore and ship); gives the user the ability to look and search further than your own sensors; the ability to have data available when needed in areas normally not covered; and is a possible fall back solution if other systems fail.

The next step would be to incorporate this service into the Maritime Cloud and make adjustments to the IALA standard together with suppliers. Maybe another EU project could help to realize this more quickly. Even with the Maritime Cloud there will be issues to be resolved, such as the quality of data being shared, who is responsible for sharing the data, new legislation will need to be put in place about data sharing. There will also be costs incurred for implementation and communication of the data

### 3.2.7 Vessel Operations Co-ordination Tool

David Andersen Camre introduced the Vessel Operations Co-ordination Tool (VOCT) - a search and rescue (SAR) focussed tool. In the EfficienSea project we experimented with sharing routes and waypoints using AIS. From this we saw the potential for sharing routes for SAR operations, as it will increase the effectiveness of sharing and transferring data from ashore to the vessels involved in the SAR operation.

The VOCT is an open source prototype providing:

- Calculation of search areas and patterns (based on the International Aeronautical and Maritime Search and Rescue Manual; the IAMSAR Manual)
- Import of SAR data from commercial drift calculators
- Communication of search areas and patterns from Search and Rescue Coordinators ashore or at sea to Search and Rescue Units
- Search and rescue unit tracking and management
- Geographic presentation of search areas/patterns, including areas effectively searched
- Shared log functionality and short text communication

It is a means to effectively distribute, share, calculate and monitor search and rescue operations between users, and communicate between them through the interface.

Here is a picture of the VOCT on the e-Navigation Prototype Display (EPD) showing a communicated search pattern based on the sea conditions, the weather conditions, the vessel's time, place and characteristics and the nature of the subject you are searching for

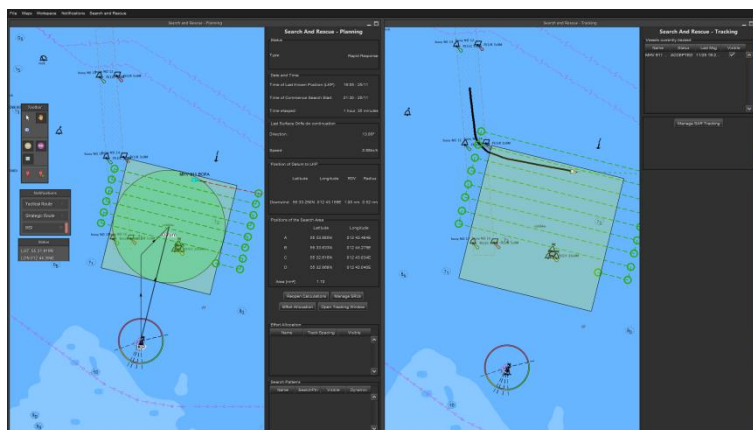

As part of ACCSEAS we conducted a test with the Danish Home Guard, we also went to Den Helder and tested the solution with the Dutch Coastguard. A video of this demonstration which can be viewed here: <https://www.youtube.com/watch?v=HXgcQra4PjM>

Results from the VOCT demonstrations will be used for input to IMO NCSR to prompt further development of SAR Data Sharing concepts and standards; there will be further development of the solution based on the output of the testing; as well as further live testing in the Baltic SAREX (a large multi-nation SAR exercise).

### 3.2.8 Dynamic Predictor for tugboat operation

Peter Grundevik of SSPA explained the dynamic predictor solution. Sometimes it is difficult to foresee future ship positions as a result of change in rudder turn or steam. A conventional predictor uses speed over ground (SOG), course over ground (COG) and rate of turn (ROT) to predict the movements of other ships. SSPA's dynamic predictor uses SOG, COG and ROT, but also depth, draught, trim, wind, rudder angle, propeller pitch/rpm and hydrodynamic ship modelling in its predictions.

The dynamic predictor was installed on-board a Stena Line Ferries vessel with a very positive attitude among the users. In the EfficienSea project, an investigation and testing was conducted of an operational service offering exchange of dynamic predictor positions between nearby ships. The conclusions we found from the exchange of positions was that it resulted in too much information and that it didn't prove useful in collision avoidance. However it was found to be useful on board their own ship when making precise manoeuvres in ports.

Within ACCSEAS, we looked at whether predictor exchange was useful in manoeuvring with tug assistance, proposing the use of the predictor at the beginning and end of a voyage as well as for immediate (a few seconds ahead) planning (not strategic).

We tested this in simulators measuring: the time period for the operation; the speed when landing on berth; the repeatability of the manoeuvre; the safety margins, before following this up with interviews with Pilots and Tug masters.

Here is a picture of the predictor in action on the simulator:

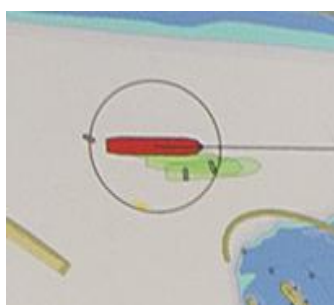

And here it is in the EPD:

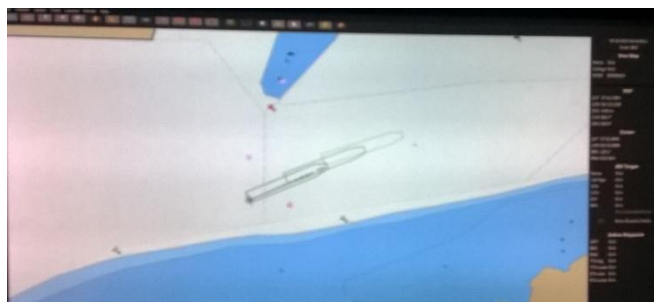

We tested the predictor in set conditions and on a pre-agreed vessel type. Five test situations were used:

Test 1	Today situation – no predictor used
Test 2	Simple dead reckoning predictor used
Test 3	Dynamic Predictor used and shared, no forces exchanged
Test 4	Dynamic Predictor & forces exchanged, ideal forces
Test 5	Dynamic Predictor & forces exchanged, resulting forces

The conclusions from the scenarios were that:

- The pilot operating the test ship considers the dynamic predictor with ideal or resulting forces to be an additional help;
- The simple dead reckoning predictor is considered to be of less use;
- Tug masters expressed that the situation awareness was improved by ROT and dynamic predictor information;
- No significant difference in time, safety margins, landing speed or use of power can be concluded with certainty;
- A tendency can be found when introducing the dynamic predictor: assistance in learning the ship behaviour.

More tests are needed to look for significant results, with tests on more complicated, larger vessels like VLCC recommended.

We also looked into AIS-based Risk Evaluation as a possible solution:

- Collecting a lot of historical AIS data sets a normal ship behaviour;
- By looking at real time AIS data and compare them with the stored normal behaviour, abnormal ship behaviour can be detected;
- Vessels that deviate from normal behaviour may represent a risk which can be identified;
- A system using this technique can help VTS operators to identify ships sailing an unexpected route;
- Such an algorithm was tested using logged AIS data on known accidents in Swedish waters.

Conclusions:

- Based on normal ship behaviour it is possible to automatically identify ships diverging from the normal behaviour and alert VTS operator or the Officer on watch;
- The algorithm was tested using high quality AIS data from about 20 real grounding accidents. The system did warn in almost all cases, except some few very special occasions (not leading to groundings);
- The technique is developed further in MonaLisa 2 and the results are very promising.



### 3.2.9 Automated FAL Reporting

Jon Leon Ervik presented Automated FAL Reporting. He presented why the project decided to develop it, what was and was not achieved.

Of IMO's 5 agreed e-Navigation solutions, FAL reporting is featured as a "means for standardized and automated reporting".

It is agreed that Automated FAL Reporting should automatically produce and report FAL documents. ACCSEAS produced a very basic PDF service with too limited resourcing for a complete testing environment, though it is a good starting point for further work.

How are we currently doing FAL reporting:

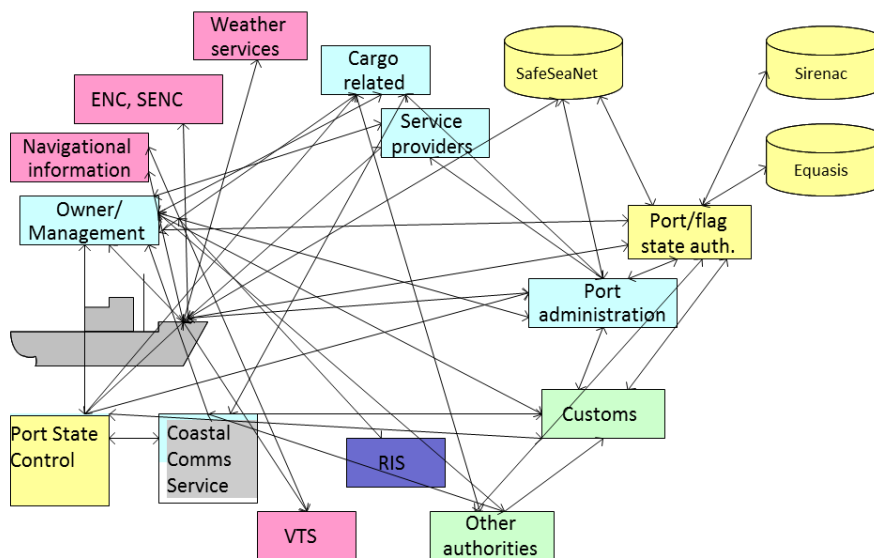

How it could be done based on the "Single Window" concept

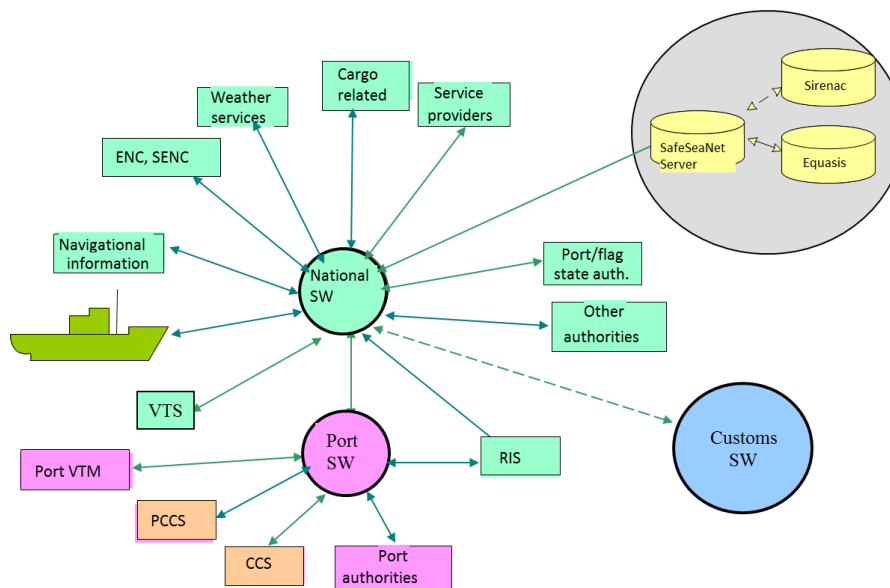

What is SafeSeaNet (SSN)? The European Commission & EMSA (European Maritime Safety Agency) want to improve ship reporting. The SSN concept is a system designed and

built to collect and exchange data, provide services and serve as a platform for collaboration. In Parallel Norway has developed the single window concept, wherein every ship entering a Norwegian port should only need to send a piece of information once, featuring a single window with all authorities included.

This resulted in the 2010-65 directive, with a complete single window concept implemented by 2015. The concept has been developed, it is possible, and we consulted an S-100 engineer who said it is possible to develop this in that framework.

As an example of the efficiencies: before we implemented this in Norway, the police manually checked the crew list against the unwanted people's list. This is now automated.

Using the SSN in Norway led to 245,000 fewer forms filled in in 2013 – an equivalent overall reduction in work by 140 full-time people.

The next step is to further develop FAL Reporting in the MonaLisa 2.0 and Sea Traffic Management Project.

### 3.2.10 Q&A Session

No-go Area Service: can this software run on commercial ECDIS systems in deep-sea areas. Can we get live tidal data to vessels outside of coastal areas?

David Camre replied that technically it is possible. We are not talking about a lot of data being transferred; it is a simple polygon, not the full data picture that is being transmitted. Thomas Porathe added that this is a service that will be made available in certain areas dependant on the providers. There will be different publishers of data based on where the data is coming from and trust issues inherent in that.

A second audience member remarked on the No-go area service. To Thomas Porathe: you talked about officers who did not use the ECDIS correctly – we mustn't forget that we have to train people to use the tools. How can we think about training with this tool?

Thomas Porathe: the foreword to the MAIB report on the Ovit incident mentioned in my presentation says that this is the third instance of insufficient handling of an ECDIS. We have built a complicated system that requires a lot of training to get it right. A goal of e-Navigation is to make the services intuitive and easy enough to use so that we don't run into these issues all the time.

The third question focussed on IVEF: in the presentation you mentioned that the extra radar information from the vessels will cover the gaps in the region. What about the small ships that don't have radar exchange? How do you propose we monitor them as well?

Jeffrey van Gils: with this concept you have large ships with radars which help you to cover more areas the region. If a small ship is near a large one it will be detected. If it gets more integrated into normal systems you get a better coverage of an area.

A follow-up remark: what about labelling? If a small ship disappears from radar range and reappears again, how will it be recognised?

Jeffrey: this is a problem yet to be solved, but it is an improvement that you see there is a vessel at all.

Another follow-up comment from a Pilot who noted that he has a PPU system that receives radar, and we find it useful to know WHERE smaller craft are but not WHAT they are – labelling in this instance crowds the picture

The fourth question focussed on how you can ensure data security in IVEF.

Jeffrey: we have a secure connection between ship and shore, and we can measure multiple outputs on a ship to check integrity.

The fifth question was regarding the No-go Area service: does it work with data from other types of chart, for example on a non-mandated ENC? If we use nautical data with insufficient input the output can be misleading and potentially dangerous.

Thomas Porathe: if the No-go Area service is going to be of any use we will need better, more hi-resolution bathymetry data. This is often classified and not available. What the system does is request just one contour for a specific level and not the whole picture, which may resolve the issue of clearance for data.

David Camre added: the data used in ENC charts may be lacking, but currently we use hydrographic data direct from the surveyors. The end-user does not see the individual data points, only a simple polygon (yes/no) data.

Thomas Porathe added: one of the plus-points of a test bed is that we get the test a solution and develop the standards after, so issues like this will be ironed out.

## 4 Day 3

### 4.1 Workshop Results

#### 4.1.1 3rd North Sea Region End User Forum: A Sparks from ACCSEAS

Jan-Hendrik Oltmann and Nick Lambert presented the results from the workshop.

The first thing the workshops did was to provide general comments about ACCSEAS, the consensus was as follows:

- The project was hugely successful, doing work that people have talked about but not delivered. It was scored between 7 and 8 out of ten.
- There should be something done with the project, or a follow-up “ACCSEAS 2.0”
- The solutions and themes from the project should be commercially exploited and soon.
- Resilient PNT was mentioned a lot by participants, agreeing that a backup with accuracy such as we have seen in ACCSEAS, should be done.
- The solutions should be supported by the maritime cloud.
- How can we engage the results of the project to the wider world?

In this workshop we then asked participants to provide ideas and feedback for each solution proposed by the project – they were then asked to rank the ‘sparks’ based on priority. This was repeated twice and the results were as followed the solution name is in bold followed by a summary of the ideas. The lists are ranked by priority, where 1 is highest:

#### Workshop 1 Sparks

##### **1 (16 points) Innovative Architecture for Ship Positioning:**

Create a R-Mode Testbed involving several countries, integrate it into the Multi source positioning receiver, investigate maniners interest in R-Mode and define a road-map for R-Mode-IMO approval

##### **2. (13 Points) Maritime Cloud as an underlying technical framework**

Continue to develop MC by e.g. making a body responsible with the goal to reduce diversity of communication means but still maintain existing radio communication system

##### **=3 (8 points) Vessel Operation Coordination Tool (VOCT)**

Implement VOCT as soon as possible and enhance the SAR capabilities

**=3 (8 points) Tactical Exchange of Intended Route**

Further develop for efficient port arrival and departure scheduling, by e.g. using interactive routing, automatic ship/ship exchange on proximity.

**=5. (6 Points) Route Topology Model for NSR**

Develop RTM to release its full potential in support of the logistics chain (including a view to the hinterland of ports)

**=5 (6 points) Innovative Architecture for Ship Positioning:**

Define who shall organise multiple PNT systems, in particular regarding responsibilities

**=5. (6 Points) MSI/NM Service**

Help with VDES development

**=8. (5 points) Augmented Reality / Head-up display**

Work on Data integrity

**=8. (5 Points) MSI/NM Service**

Continue standardisation to S-100 and make it useful in such a way that you can calculate with it (use in voyage plans, ECDIS charts adaptations, ...)

**=10. (4 points) Harmonized Data Exchange employing IVEF**

Harmonize IVEF and IEC 61174 (ECDIS spec)

**=10. (4 Points) Maritime Cloud as an underlying technical framework**

Do specific work on cyber security

**=10 (4 points) Vessel Operation Coordination Tool (VOCT)**

Make SAR functionalities available in every ECDIS

**Workshop 2 Sparks****1. (18 Points) Maritime Cloud as an underlying technical framework**

Continue develop MC as a fundamental infrastructure for seamless data communications with appropriate means (dedicated working group, e.g. at IALA) and promote it

**2. (10 points) Automated FAL Reporting**

As a "low hanging fruit" this should be developed and maintained, but not by duplicate efforts.

**3 (9 points) Augmented Reality / Head-up display**

Develop more prototypes with the goal to broaden experience on the best way to present augmented views in head up (e.g. By forming a Human Factors specialist group or by trying headtracking like X-Box)

**=4. (8 points) No-Go-Area Service**

Develop pilot implementation at a few ports (such as port of Hamburg, Rotterdam, Antwerp) and align with existing BENC services as developed by industry already

**=4. (8 points) Maritime Service Portfolios (MSPs)**

Prioritize and develop product specifications

**=4 (8 points) Tactical Exchange of Intended Route**

Publish a standard for route exchange

**7 (7 points) Innovative Architecture for Ship Positioning**

Keep and expand eLoran infrastructure as a backup for GNSS by find European funding for eLoran

**=8. (6 Points) Route Topology Model for NSR**

Develop into a finalized product and test it (use cases; maintenance during life cycle etc.)

**=8. (6 points) Real Time Vessel Traffic Pattern Analysis & Warning Functionality for VTS**

Develop into a concrete application by e.g. forming a dedicated group

**10. (5 Points) MSI/NM Service**

Finalize the development of MSI/NM Service including the restructured workflow for MSI/NM updates in the regulatory domain by focussing on replacement of NAVTEX and by developing IHO S-124 specification

**4.1.2 3rd North Sea Region End User Forum: B The Monitoring Navigator**

This workshop was facilitated by Dr Michael Baldauf and Mr Stephan Procee and covered the participants' feeling about the idea of a Monitoring Navigator. Below are the themes that emerged

**Today's situation**

Today's mariner is coping with kind all of problems. Dr Michael Baldauf discussed how a mariner's voyage plan can change; the technical issues they face, how they are informed, and what is done to overcome the issues.

Today's situation is driven by a number of pressures from today's business and cargo handling industry, balanced with the drive to safely and efficiently conduct a voyage from berth to berth. We require and want maritime shipping to be environmentally friendly and safe without accidents and it should be.

We must pre-plan and have the right solutions and dynamic voyage planning tools that support the mariner; port authorities need to be well aware of arrival time. ACCSEAS has played a role to support this and the hope to have zero accidents in the future.

**The Monitoring navigator....**

All developments in navigation focus on the human element – the human operator. The navigator is becoming the monitoring operator, where IT experts are providing solutions. The worry is that machines take over the ship's navigation but we want to have the human navigator still in the loop.

**What is a perfect alarm?**

The perfect alarm only triggers when needed. It is for accident avoidance.

We see in accident (or near miss) investigations it is often caused by 'human error'. Often it is that the wrong action was taken after an alarm, the Costa Concordia is an example of this. Very often in the case of a collision it is because the alarms were switched off so there was no warning. Here the responsibility is still with the navigator.

Learning from Air Traffic Control: in 2007 there were 9 near-miss collisions per day on average, with a peak of over 20 possible accidents per day. This sort of data created the need for an improved collision alert system and tools to improve situational awareness.

In the IMO standards one module specifically deals with three different levels of alarms:

CAUTION – be aware

WARNING – requiring attention

ALARM – respond, do something

But what is a perfect alarm?

The air traffic industry has defined corridors for movement, whereas shipping space is freer. In maritime traffic, there are no rules to say what safe passing distances are, there are only recommendations.

Manoeuvrability suggestions could be made using the tools ACCSEAS has developed. Dynamic prediction algorithms can be used to help with predicted voyage tasks and to reduce risk. It is possible to start by risk indexing – producing a list of different types of risk encountered in the maritime domain and create situation-dependent alerts for collision avoidance.

Enhanced displays and integration of information also support being able to create the “perfect alarm”. Enhanced and integrated situational awareness alarms will support the monitoring the navigator who is already busy and possibly distracted with other tasks. Head up display will give an instant indication to help the mariner decide the next manoeuvre.

Can we create an environment where there will be zero accidents and a completely reliable situation for the mariner, hence creating “The Monitoring Navigator”?

What is the real intention, what do we want: to give technology the ability to monitor the navigator, or give the tools to the mariner to help them monitor their navigation plan better?

What has been developed will support the position of the active navigator to make all of the decisions. AIS is recognised as improving the situation but not all vessels operate using SOLAS. Not all vessels use AIS information as a must. AIS and radar are both needed.

### **Can automation take over?**

Automation must know all the possible situations/outcomes. The problem is all accident situations are different. The design is very important. All scenarios must be known in the design of a tool to be able to offer a reliable tool.

### **And ashore**

Shore-side support is also important. It should provide advice and instruction to contribute to safe and efficient traffic flow and must have the capability to interact with the navigator. Any solution must be able to improve accessibility to ports.

With VTS monitoring: they can assess if there is need to interact and send out warnings or instructions. Traffic separation schemes are in place and VTS are already providing services in a defined manner.

Fleet Operations Companies (FOC) are conducting shore based monitoring from very large monitoring screens showing company owned ships activity, energy use, and voyage path. Manufacturers are already providing these types of monitoring services to FOCs, they provide additional monitoring so that they can see intended route. They can monitor the route. They know that there is an influence of current or wind. FOCs are using enhanced functions to monitor the ships and their navigation which contributes to more safety and efficiencies. Monitoring centres have almost all data needed for direct control of the ship and for direct advice to the ship which is about to berth. Companies are using those systems.

VTS operators are giving advice to a person who doesn't know what they are supposed to be doing and most operators have a 'mariner's' background. They can be contacted 24 hours a day. A well-defined clear hierarchy of actions is what all operators want.

### Comments from participants

- You are only monitoring while you are awake. Fatigue means you can quickly stop monitoring. It is best to keep busy to avoid becoming 'monitoring only'.
- There is a need for a good balance between automation and navigator interaction and ability to take control.
- We heard this morning about the grounding of the Ovit. The decision was made to put two more buoys in that area. The reason is that the pilot was tired and he rushed the voyage path. The bridge team don't have the time to chart and to keep checking. We need to be honest about why these groundings happen.
- New traffic separation schemes should be updated to support new passage planning. If pilots use out of date data then accidents will happen. I am concerned that shipowners make these decisions primarily based on finance efficiencies and crew reductions is possibly not the best answer.
- The absolute truth is that we don't have hundreds of collisions and groundings and those few that use the tools incorrectly have done this mainly because they are tired. I'm worried about the tired navigators most as this seems to be the most honest reason why these things go wrong.
- A monitoring navigator gets a lot of alarms. Instead of alarms these tools can give them solutions, and the mariner still makes the decision. It is an advisory role that helps you make your decision

#### 4.1.3 3rd North Sea Region End User Forum: C North Sea Region future challenges

This workshop was looking at the IMO's Maritime Service Portfolios (MSPs) and the ACCSEAS candidate solutions. It had the aim, with feedback from the regional stakeholders/users, to prioritise the implementation of e-Navigation services for the region.

There were a number of key considerations when prioritising the implementation of the solutions, which were:

- Safety of Navigation
- Accessibility of the area and its port approaches
- Efficiency of Shipping (voyage)
- Efficiency of Shipping (logistics)
- Secure navigation and transport
- Enhanced management of traffic
- Enhanced data management
- Search and Rescue
- Incident and Accident response
- Protection of the environment
- Enhance planning tools for navigable waters (Marine Spatial Planning)
- Existing / Comparable service(s) needs to be improved
- UNCLOS

The below is a table of results from the workshop showing how the members prioritised each solution. Firstly the IMO MSPs from the SIP. Each number in the 'High', 'Medium' or 'Low' column is a vote from the workshop participants for the corresponding level of priority for the service.

No.	IMO's MSPs (SIP)	High	Medium	Low
1	VTS Information Service (INS)	24	6	0
2	VTS Navigation Assistance Service (NAS)	12	12	5
3	VTS Traffic Organization Service (TOS)	18	10	4
4	Local Port Service (LPS)	6	13	11
5	Maritime Safety Information (MSI) service	23	8	0
6	Pilotage service	10	13	7
7	Tugs service	9	7	13
8	Vessel - Shore reporting	20	11	1
9	Remote monitoring of ships systems	5	5	20
10	Telemedical Maritime Assistance Service (TMAS)	6	9	16
11	Maritime Assistance Service (MAS)	4	12	12
12	Nautical chart service	14	13	3
13	Nautical publications service	12	12	5
14	Ice navigation service	5	9	18
15	Meteorological information service	15	14	1
16	Real-time hydrographic and environmental information services	18	13	1
17	Search and Rescue (SAR) Service	20	10	0



And the same for the ACCSEAS candidate solutions

No.	ACCSEAS candidate Solutions	High	Medium	Low
1	Multi Source Positioning Service	20	8	4
2	Tactical Route Exchange Service	11	17	4
3	Maritime Safety Information/Notices to Mariners (MSI/NM) Service	23	7	2
4	No-Go Area Service	13	15	2
5	Route Topology Model (RTM)	9	11	11
6	Augmented Reality / Head-Up-Displays (HUDs)	1	13	16
7	Automated FAL Reporting	15	9	6
8	Maritime Cloud	18	10	3
9	Vessel Operation Coordination Tool (VOCT)	13	14	6
10	Dynamic Predictor (for tug boat operations)	1	5	22
11	Harmonized Data Exchange – Employing the Inter-VTS Exchange Format (IVEF) Radar images ship/shore vv	10	15	6
12	Real time warning system based on historical AIS targets behaviour	5	8	16

### IMO's MSPs Conclusions

- Prioritized development and implementation: 10 out of 17, all of which are Safety of Navigation related
- Highest priorities are number 1 (plus 2 & 3), 5, 8, 16,17
- 1, 2 and 3 can be combined into 1 block for VTS services, leaving 5 priorities for those at our workshop

### ACCSEAS candidate solutions conclusions

- Prioritized development and implementation of 4 of the 12 solutions, all of which are Safety of Navigation related
- The highest priorities are numbers 1, 3, 7 and 8
- The low priorities are numbers 5, 6, 10 and 12
- Some further development is needed for 4, 9 and 11, but they are potentially “low hanging fruit”
- Number 5 (RTM): the benefits are doubtful, there needs to be more focus on the aim and result

Jon-Leon Ervik commented: it is important to justify the result from ACCSEAS, and the service portfolio for the region, by inputting this into the IMO MSPs. This is crucial if we want to develop something in the future that is based on the NSR.

Peter Paap: when we started with ACCSEAS we said we would follow and correspond to the framework of IMO & IALA. It is now a matter of mapping – where can we map the solutions to the MSPs. Jan-Hendrik Oltmann has written a great document on how we are mapped to the SIP and other projects which will be available soon (e-Navigation Architecture Report).

#### 4.1.4 3rd North Sea Region End User Forum: D Chances and challenges of simulation networks

Christian Grube and Gunter Schmidt presented different types of simulation training, showing a live connected simulator scenario from Rotterdam to Bremen. A feedback questionnaire was shared.

The session covered the following:

- Why we connect systems
- A live showcase – the live demonstration showed a live collision and an introduction to how the simulator data works
- The benefits of simulation networks
- What is needed for a simulation network

What is needed for an effective simulation network is: a clear set of objectives and everyone involved working to the same plan; good time management due to different local time zones; an open-source so we can work with any equipment manufacturer; technology needed must include all modern standards, IP VPN, DIS IEEE 1278, etc.

#### Feedback from the audience:

Are simulator networks:

Creating more realistic scenarios by incorporating remote/distributed resources?

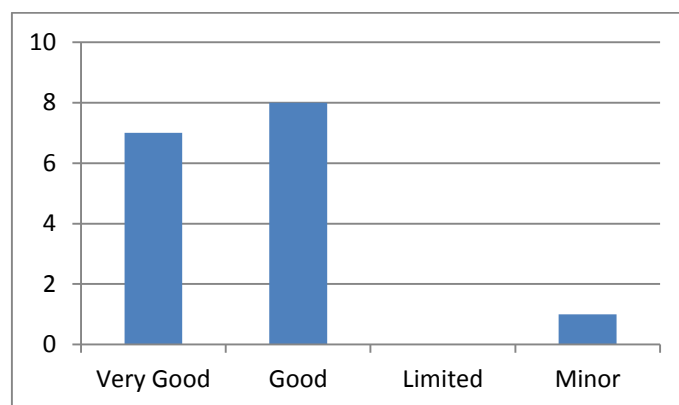

Improving simulation by means of remote cooperation?

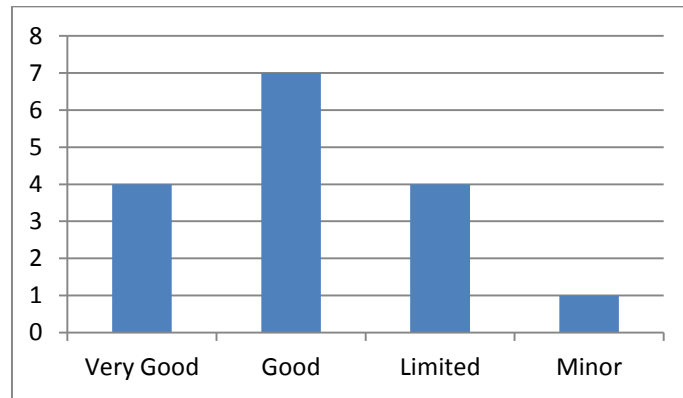

A chance to save money on simulators by accessing rarely used resources “on demand”?

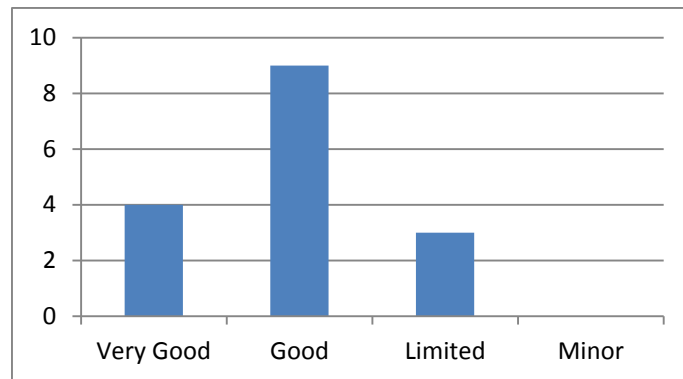

Improving access to interpersonal training and test effects like team training?

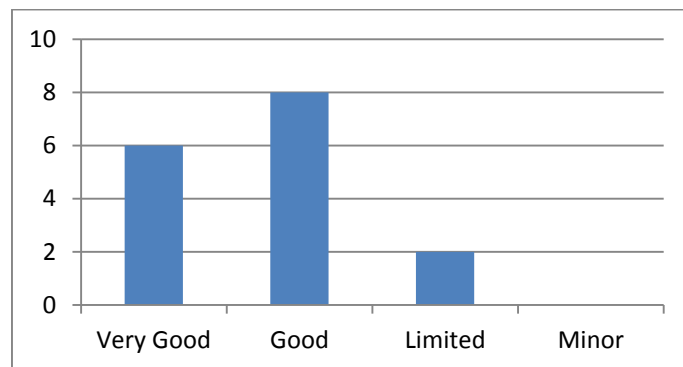

Creating opportunities to practice sharing test and training experiences between large (interdisciplinary) teams?

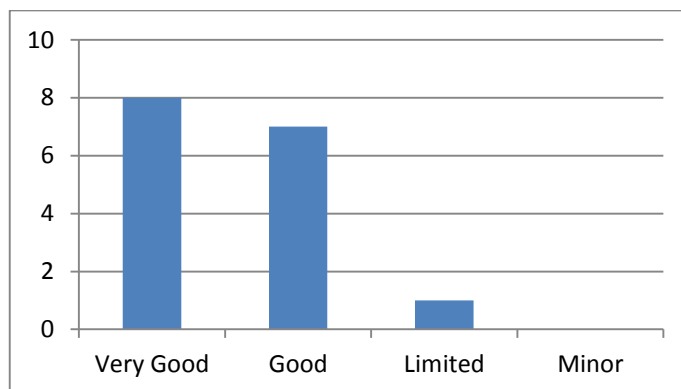

Developing harmonized maritime simulation standards by using distributed simulation?

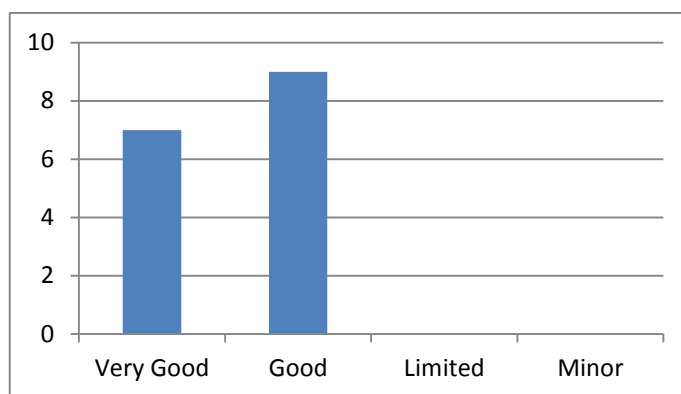

**Q&A**

A Q&A session was held with the following responses:

Q. How do you retract information?

Christian says they use a database with all the information pre-stored. They analyse the data and the simulator produces a 3D representation.

Q. Can objects from other simulators interact with each other and exchange data when simulators communicate together. What kind of data model is used?

Christian didn't want to go into too much technical detail but he talked about the objects having IDs. The simulators recognise each ID.

Q. Information is enhanced within the data model using all current standards. If any party creates anything new then other networks need to be informed. Like any other form of data release.

Infrastructure, Simulation Management/Web based Services, Perceived Truth Apps, Voice were all discussed as well as ground truth – where the ship really is – and what we know to be the truth (different from perceived truth). The data from the simulation is all sent using a secure connection (IPSec Tunnel), information is then held in SimNet.

The group then discussed the challenges. Technology, and standard compliant simulators; the requisite performance and bandwidth needed; IT Security (even with a VPN connection); and admin were all listed as key challenges.

## The ACCSEAS test-bed

Gunter Schmidt talked the group through what was done within the ACCSEAS testbed. They introduced an accurate map of North Sea windfarms into the simulator scenario. The project tested and provided simulated training for the Vessel Operations Co-ordination Tool (VOCT) and No-Go Area services. Within the project we also tested the Tactical Route Suggestion Service (shore to ship) and Exchange of Intended Route (ship to ship and ship to shore).

## Future Trends for Simulator Networks

Simulator Networks are in use now in the German armed forces as an example. There is a need for a standardised simulation network middleware. The group discussed Simulation as a Service (a simulation cloud) for data storage. Another future trend identified was the required increase in general training and interoperability training.

Q. What about costs?

A - 99% of costs are what your vendor asks you to spend on standardising your interface.

Q. Can you harmonise the procedures to set-up simulation networks?

A – A lesson learned paper being written by Mr Grube's organisation, which will be taken from 15 years of experience.

Q. If go to the US, will I be expected to plug into HLA?

A - Yes, HLA or DIS.

Conclusion:

An ACCSEAS conference delegate now knows that a clear Test/Training Objective defines the means, persons, tools and methods to achieve testing or training in an effective manner. Simulation networks can be one of these tools if you know its benefits. But you also have to consider its challenges regarding the management of: Objectives, People and Time.

## 4.2 ACCSEAS' Project achievements

Dr Alwyn I. Williams, ACCSEAS Project Manager, introduced the following film:

<https://www.youtube.com/watch?v=blvy8A492F8>

## 4.3 Legacy and Future Work, Outline Sustainable Work Plan

Pieter Paap presents an outline of the legacy and planned future work for ACCSEAS. Firstly, what do we mean by legacy? For ACCSEAS, it is divided into 3 levels: Organisational Legacy, Substantial Legacy and Material Legacy.

The organisational legacy notes the need for coordination and cooperation of e-Navigation in the NSR, including:

- Harmonized and standardized implementation of e-Navigation
- Policy decisions to be taken
- Service Providers
- Coherency and harmonized services
- Ongoing stakeholders consultation
- Dissemination of progress

There need to be coherent links to other forums for e-Navigation in the region and beyond. When ACCSEAS finishes there will be two groups, the Service Providers Coordination Group (SPCG) and the Transnational Advice and Guidance Group (TAGG), which feed into the e-Navigation User Forum, of which all of you were part during the conference. Policy element will be covered by the North Sea Region Policies Harmonisation Group (PHG).

A conference hosted every two years is suggested, similar to the coordination group that was set up for developing GNDSS, which was successful in making the North Sea Region the first area ready for developing GNDSS. To help in establishing a NSR e-Navigation platform the PHG and the SPCG will organise an NSR e-Navigation User Forum and a biennial conference. This is essential for the good implementation for e-Navigation. We have agreed that this Forum and Conference should be kept under the responsibility of in the shipping industry, but we open the door for input from OSPAR or the EU North Sea Commission. There is a preparatory meeting initiated by one organisation and a Terms of Reference is already drafted.

The research completed as an input into the ACCSEAS Baseline and Priorities report is a great starting point for the substantial legacy of the project. There is a lot of data, research and analysis that forms the first piece of substantial legacy.

Within the standardisation and architecture work package of the project, potential solutions were mapped to the IMO and e-Navigation architecture. The solutions were also brought together, with an overall architecture designed so that all the solutions were mapped in the direction of e-Navigation. All the candidate solutions were also mapped against eMaritime, Motorways of the Sea and INSPIRE. All of this is detailed in the e-Navigation Architecture Report.

There are also detailed design techniques – setting up the simulation architecture and design techniques summarised in the e-Navigation Architecture Report, the Use of Simulators in e-Navigation Training and Demonstration Report and the e-Navigation Training Needs Analysis Report.

The project also developed hardware and software, for example in developing Resilient PNT: receivers, processing software, prototypes etc. There are also system descriptions, reports, test scenarios, results and feasibility studies. The aim is to continue the development of these solutions and finalise prioritisation for implementation. We need to set the organisational and technical conditions for harmonised implementation of Resilient PNT as well as determine governance and liability issues before implementation. We also have the demonstrators and simulators we used to prove the usability of the solutions.

The material legacy has issues over governance, maintenance and future use. For example for AIS delivery, legal constraints need to be solved, where elements are restricted by privacy law.

### **Future work**

The Sustainability Workplan document, including everything we are discussing, is the guidance for continuing ACCSEAS work and follow-up projects. The legacy plan will be finalised in the final weeks of the project and will then be submitted for approval. The intention is to make it available on the ACCSEAS website along with all the other reports from the project. The website will be alive for at least one year after the project ends.

The need to disseminate our results is recognised. We will send our reports to IMO, IALA, CIRM, ITU, IEC etc, along with other NGOs and similar organisations. They can use it to further their e-Navigation work. It will also be disseminated to the EU and EMSA so that they can help determine hotspots and EU project funding. The results will also be published on the e-Navigation.net portal and any other interested stakeholder websites, with appeals for support from the industry.

## 4.4 Keynotes: Future Perspectives

We have invited four speakers with four different perspectives on the region, industry and project to share their views of the ACCSEAS project.

### 4.4.1 Safety and accessibility, Francis Zachariae

Francis Zachariae, Secretary General, IALA, shared his view from the safety and accessibility perspective.

IALA has 105 industry members, providing aids to navigation to the mariner, as well as 58 associate members and 78 national members.

Inspiration was taken from the ACCSEAS Baseline & Priorities Report, with Thomas Porathe and Jan-Hendrik Oltmann congratulated for their work.

Here is a picture from of IALA net:

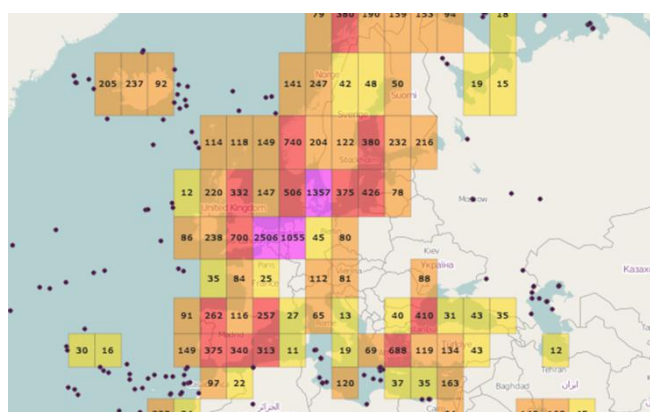

All 40 partners are sharing their AIS data, which is represented like this on the internet and distributed to our members. The purple areas are the busiest in the world, so you can see that we picked the right spot with the NSR. There is no doubt that that will continue, the Global Maritime Trends report expects the volume to double in the next 15 years, and for there to be 100 times more windmills in same time period.

There are some key figures from EMSA: there were 2550 accidents, 81 of which were serious and 51 ships lost in Europe in 2014. The Aircraft world would never accept these numbers. If you compare this to airline it would equate to one airliner crashing every day. This shows that there is lots of work still to be done.

On day one of this conference, Thomas Porathe said there are four main challenges in the region: decrease in space, increase in traffic, complexity of navigation and keeping navigator in the loop. The first two are the things that increase the complexity of navigation, and this is at the heart of IALA.

IALA believes the answer is e-Navigation. When we speak about e-Navigation, it is important to realise that it is wrong to talk about a project – one that will start and end. It is wrong to say no thank you, we do not want it – some flag states and traditional mariners are still doing it. It is not a question of yes or no – e-Navigation is a journey into the future and it has already started. It is a well-known journey in other areas of the business world, such as in the globalised nature of banking. The importance is in the business case: we must highlight the value for the mariner or the ship owner.

In the Navy 30 years ago, we had Sea Three; and on most pleasure boats, the mariner has an iPad and can access charts with e-Navigation-type data. Another tool already available is the Arctic Web, with routing, weather data, safety information and ice updates. So these things exist and are being used. The challenge for IALA is harmonisation.

We have a guideline for testing and reporting; we have a test-bed in Korea which is discussing the same things as here. Global communication is happening. It is a challenge to coordinate these projects, but as someone who has been part of many of them, we see that we are already building on the results of them by linking projects (see the way MonaLisa's results feed into MonaLisa 2.0, or ACCSEAS, or EfficienSea). IALA will take the reports, send them to committees and make sure it is taken on. We will set up a working group on the maritime cloud, and VDES.

There is a promising future for the maritime world. I would like to congratulate Mike Bullock and Alwyn Williams and all the partners on the ACCSEAS Project. This project is well executed with very important results that will all go into IALA's work programme.

#### **4.4.2 Shipping perspective, Fredrik Van Wijnen**

Fredrik Van Wijnen presented the perspective on behalf of the shipping industry.

I arrived here an hour late because there was a signal failure on the train. We have heard a lot of solutions but if there is a technical failure, we are still stuck. The solutions are fantastic but we need to be sure that the backups of traditional navigation continue as well.

I represent the navigators. I have a yacht and am regularly in the North Sea, the safety of the leisure users is also important and I believe will be helped by ACCSEAS.

It is a pleasure to speak on behalf of CESMA. I will speak from the perspective of safety in North Sea Region. I represent our members – who come from all corners of Europe and contain the knowledge and experience of over 2000 shipmasters and navigators.

The North Sea area is and will become more and more important for carrying routes to and between ports in European nations. With the EU' Motorways of the Sea concept, which CESMA participates in, sea traffic will likely grow even more. Moreover there is a growing demand on users based on the increase on other stakeholders in the region: such as renewable wind energy. This impedes shipping traffic and amends existing lanes to accommodate them. The size of vessels is another issue.

ACCSEAS has attacked these problems by developing solutions to mitigate this.

CESMA is following the work on unmanned vessels with great interest. We know that tests have taken place on unmanned vessels, trains and cars. Which shipping insurance firm will approve of unmanned ships? But why do we need to do this at all? It is because staff on board ships are one of the few things you can economise on. We see crews are being reduced as far as possible, so why not reduce it to 0 if we can?

Though accidents have been reduced there are still a lot of high profile incidents. Shipping accidents should be properly investigated including flag states and other stakeholders.

Another issue is that vessel crews are declining in competence as a consequence of regulations. I have heard it being told that this is due to under-experienced mariners being promoted as a result of not enough interest in the career in general.

CESMA believes ACCSEAS has made a real contribution to accessibility in NSR.

#### **4.4.3 Green perspective, Sjon Huisman**

Sjon Huisman communicates the green perspective on the project.

Thank you for inviting me to represent the BONN agreement. We have put a lot of effort into the green perspective on shipping. We started in 1969 as protection in case of a major tanker incident and have done a lot since.

The Bonn Agreement area is the Greater North Sea and its wider approaches.



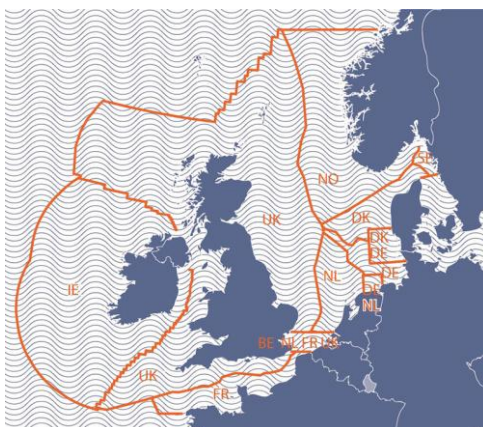

This region has a variety of different hydro and geographic characteristics, with changing shorelines and coastal habitats as well as diverse marine habitats. The BONN Agreement is here to work with industry to protect them.

We have an increase in protected marine areas in our region and we need to consider how we can protect what needs to be protected while allowing industry to continue. We are pressing shipping into sensitive areas and are keen to take care of risk-reduction.

The BONN Agreement set up the BE AWARE project, conducting a risk analysis and proposing a harmonised approach to protecting the environment. We looked at 2011 and 2020 and studied collisions and groundings, to learn how best to deal with these situations. We analysed the likelihood of different sized oil spills and did a qualitative analysis of the likelihood of certain spills.

The project produced a map of the results of this study, identifying that the main risk of pollution was due to collisions involving ships – especially large tankers. The frequency was mainly spread at the areas with the most traffic. This helps with preparedness.

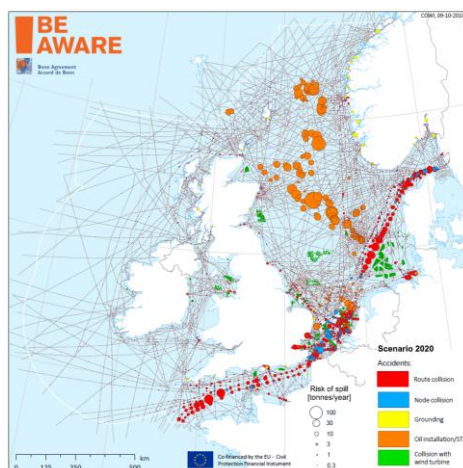

Now we know about the frequency of the risks in the region – we turned our focus onto the impact of such spills and how can we reduce the risk. So we have set up BE AWARE II.

We use regulators such as IMO and EU, increasing awareness for the stakeholders at national and sub-regional level. We are monitoring what happens, training of operators to be prepared. We identified possible scenarios and improved navigational aids, increased response capacity and improved response technology.

There is a massive incentive for ship owners to reduce risk because that reduces insurance costs and the costs of dealing with spills.

We then moved our focus more specific, tailoring our approach to individual sub regions and their requirements for spill response. This way we can quantify the required response for

each scenario. We also assess the environmental and socioeconomic sensitivity of specific areas and what the impact of spills would be.

We expect to produce maps showing vulnerability based on seasons, as well as models and outlines for the impact in different scenarios generally and sub-regionally. We will show the cost-effectiveness and conclude on risk management.

We have studied the outcomes of ACCSEAS and the relations between it and the BONN Agreement. In ACCSEAS we trust – the rest keeps a sharp look out.

#### **4.4.4 Port perspective, Rob Gutteling**

Rob Gutteling, former ferry master and now Harbour Master at the Port of Rotterdam provided the port perspective on the project.

ACCSEAS has accessibility, efficiency, advantages and sustainability at its core – all of these are important to Rotterdam port, the biggest port in Western Europe and 9<sup>th</sup> or 10<sup>th</sup> in the world.

We also aim for improved maritime access to NSR, reducing navigational risk. We agree that effective marine services are more important than ever. Access to our port is crucial for its success. We not only consider shipping in this respect; but also the offshore industry, the fishing industry and the wind energy industry all have a stake in the North Sea.

When you consider the current spatial planning trends in the NSR it begins to look like a city street plan. This is a challenge to traditional shipping and something we have to embrace and work with. We are adjusting the schemes in our approaches to take into account MSP. Traffic Separation Schemes (TSS) have been shifted to the west, as well as shipping lanes and anchorages around approaches. All of those activities have legitimate reasons for claiming maritime space.

We need sufficient space to facilitate shipping in these areas, but we also need to make the users aware of the new challenges in the North Sea. Required distances between TSS and wind farms have been agreed. We must also make the changes to adjust MSP for the priorities of coastal nations. The only solution for correct MSP is cooperation between organisations – ACCSEAS is commended for its international partnership.

Besides planning, other elements are important in accessibility to our port, including e-Navigation. The ACCSEAS test-bed, particularly the No-go Area solution, has our attention. I have sailed with both paper and electronic charts and in both the master had to draw the no go areas himself, making complicated calculations. This ACCSEAS solution offers a fantastic improvement and increases safety. The opportunities to interchange data between VTS and vessels will enhance safety and contribute to lowering of risk at sea.

Solutions and new dilemmas have seen the light thanks to this project; Rotterdam port is interested in the time-scale for implementation. We are keen on the results from Resilient PNT results. But where is the cost-benefit analysis and who will sponsor and support the solutions going forward? IMO and member states need to take the lead.

We support technological developments and encourage more projects, which with the right support will add value for the future of the industry. EU projects like ACCSEAS have had positive effects but sometimes do not have the final outcome. They should not result in another project, or a report gathering dust. We hope that it will lead to actual implementation of solutions. I hope this conference has offered you inspiring and useful days, as it has for Rotterdam port.

#### 4.5 Debate - Future Shipping in the North Sea Region

A panel made up of Alwyn Williams, Rob Gutteling, Sjon Huisman, Fredrik Van Wijnen and Francis Zachariae answered questions from the audience.

Question 1 from Pieter Paap to Rob Gutteling: I am inspired by your encouraging attitude. When we started the project the initiators tried to encourage a port to participate. Can you explain why ports in general are hesitant to take on these projects? When we are talking about legacy, going forward with our results, the participation of ports is essential in building the bridge to inter-modally. Can we count on you in future?

Answer, Rob Gutteling: All ports are interested in their own port areas, this is their main concern. General themes outside their area are of interest, but they often see navigation within their port as already being taken care of by pilots and VTS centres.

Comment from Roger Barker to Rob Gutteling: You mentioned the working relationship in the NSR with wind farms and other stakeholders. We in the UK are careful to look at each individual development, with strict criteria on the size of shipping channels through the wind farms.

General comment from Roger Barker: Regarding the promulgation of MSI. One of my jobs is to register Pilots and I hear their comments about the things they see when they board vessels. They encounter micro-management from ashore, a reluctance to stray from the red line that has been dictated to the officers on board and an inappropriate use of technology. I welcome electronic, automatic communication of MSI, because few people plot navigational warnings on charts because it is too difficult. I also welcome the common information exchange and simplification of FAL reporting. Also the lack of a PNT backup is scary and needs to happen.

I also have fears about the reduction of crew size. A grounding happened off the coast of Scotland in February, where it hit the beach at 14 knots. Was the mariner tired? Another example: in the east sunk channel outside the Thames, a man a man who navigated wrongly because he used the previous trip's passage plan without noticing that the TSS had changed – he very nearly caused an accident.

Fredrik Van Wijnen response to this comment on crew size and fatigue: this is a really important issue for CESMA. It clearly is a major cause of accidents in shipping. One of the key things we want to do in CESMA (and ACCSEAS) is avoid accidents. There remains a human factor, and decisions are being made by incompetent and not well rested mariners. CESMA participated in a Horizon 2020 project measuring rest/work hours – but are these people actually resting when they are not on the bridge or are they doing other things?

Roger Barker: I support the solutions, but we have to remember the ones who will not use them appropriately. Perhaps we could have courses in resource management on the bridge. One of the things mentioned during the conference is the need to keep the navigator in the loop. In the future – what are we going to do to keep the navigator in the loop?

Alwyn Williams: In ACCSEAS all the solutions have the navigator at the heart – to enhance what they do. We have to be careful about how e-Navigation is portrayed – a little bit 'star wars'. This is not what e-Navigation can provide to the navigator. We put the user at the heart, shore and ship side. We need to reduce the alerts and increase solutions. Give the user choices instead of problems. We don't want to overload the mariner with too much information. What the demos have shown is that the solutions can be simple to use, intuitive and inform the user of what is going on in a simple way. There were comments at the simulator trials saying 'we will miss this when we go home'.

Question 2 from Anders Brodje for Alwyn Williams: Can you pin point one ACCSEAS solution that can carry the e-Navigation message forward from ACCSEAS.

Alwyn: The Resilient PNT message is important, and supports everything we develop. Before we can provide these solutions, we need to know where the ship is. Also the Maritime Cloud underpins everything from another angle. It gives you the ability to share information with all the actors in the maritime space. But it is in the combination services that situational awareness is at its strongest.

Francis Zachariae supports idea that the Maritime Cloud is crucial: I was in Korea where they are also building solutions around the Maritime Cloud, the first step to making it global.

Fredrik Van Wijnen: I attended the workshop on the Maritime Cloud, it is new and interesting to me. Masters get a lot of information, it is important that they get the important information and not to overload them with superfluous data.

Question 3 from Wim van Buuren: ACCSEAS has more than satisfied my expectations. I was asked to join as a representative of pilots but refused because I felt it meant a lot of results but nothing happening. I get the feeling that ACCSEAS is making a lot of recommendations to IALA, IMO, EU etc. Your task is to advise and work hard towards implementation. Is there a stream within ACCSEAS that lobbies for the solutions to be implemented? Are there member states that are keen to take the lead? Can we make this go faster?

Fredrik Van Wijnen: I have been at CESMA for 15 years and agree about the results of projects going unnoticed and unused. We all agree ACCSEAS is worthwhile – we should approach people with influence in these bodies with the message. It would be a loss if in three years we hear ‘what was ACCSEAS?’

Pieter Paap: we often talk about the “low hanging fruit” in the project - if a solution is ready we should implement it. For example the VOCT is ready – so let’s implement that one.

I was also interested in the discussion about the mariner on board (Roger Barker). In the project we identified a gap between theory, training and practice. My concern in light of Roger and Fredrik’s words: when we introduce e-Navigation can we keep the training at a level that the mariner can cope? There is an action on the maritime community to conduct an ongoing training gap analysis so that we make sure we can modify training in line with technology.

Question 4, Durk van Willigen asked Rob Gutteling: Is there any backup in case GPS fails? Do we have a spoofing detection network? How do we guarantee the safety of navigation in Rotterdam?

Rob Gutteling. We have regular meetings about backup possibilities. Our current backup is sight and radar.

Fredrik Van Wijnen: With the new sulphur regulations it was expected that cruise ships would avoid the NSR to stay away from Emission Control Areas (ECAs) and the added cost of compliance. The Irish say that they are experiencing an increase in traffic there, where there is no ECA. The traffic in the NSR in general may be influenced by ECAs.

#### **4.6 Close - Conference Chair, Mr. Kees Polderman**

The primary aim of the conference was to present, demonstrate and discuss the test-bed results to and with you. This aim has been met.

There is a clear message that came from you all: the work and results are promising, they are workable. Please follow it up and make it work as soon as possible. Be practical, be fast. Do it. Make it work.

He thanks the audience, the organisers, speakers, technicians, and workshop leaders.